



Versatility & Value by Design



2025 Catalog

[AleraDetails.com](https://www.aleradetails.com)

Table of Contents

Use this reference to quickly locate the products you want.
Products are organized by section for easy navigation.

Modular Furniture	Laminate Collections • Seville • Valencia • Open Office	3-10 11-21 22	3-22	
Ergonomics	• Sit to Stand Desks & Accessories • Backrest & Footrest • Chair Mats	24-26 27 28	24-28	
Tables	Table Collections • Conference • Training	30-31 32-33	• Hospitality • Folding 34 35-37	30-37
Reception & Lounge Seating	• Soft Seating • Sectionals • Guest Chairs & Benches • Reception Desk	39 40 41-42 43	39-43	
Seating Collections	• Elusion • Etros • Wessex • Big & Tall • Mesh Back • Upholstered	46-47 48 49 50 51-52 53	• Bonded Leather • PU & Faux Leather • Stools • Interval • Folding & Stacking • Guest Chairs 54 55-56 57 58 59 60-61	46-61
Metal Desking & Storage	• Lateral Files • Vertical Files • Mobile Peds • Storage Cabinets	63-68 69-72 73-75 76-78	• Bookcases • Wire Shelving • File Carts & Garment Carts • Metal Desking 79 80-85 86-87 88-89	63-89
Accessories	• SOHO Furniture • Lamps • Fans	91 92 93	• Heaters • Refrigerators 94 94	91-94
Icon Index	<div style="display: flex; justify-content: space-between; align-items: flex-start;"> <div style="text-align: center;">  Freight Shippable </div> <div style="text-align: center;">  Extended Leadtime </div> <div style="text-align: center;">  Assembly Required </div> <div style="text-align: center;">  Alera Access Plus </div> </div> <div style="display: flex; justify-content: space-between; align-items: flex-start; margin-top: 10px;"> <div style="text-align: center;">  Meets ANSI/BIFMA standards </div> <div style="text-align: center;">  Small Parcel Shippable </div> <div style="text-align: center;">  Certified by NSF International. </div> </div>			

©ESSENDANT 2025 Printed in the U.S.A.

Prices shown are in U.S. dollars and are subject to change without notice; we encourage you to confirm prices when placing your order. We reserve the right to correct pricing or copy errors and to limit quantities. Company and product names appearing in this catalog are the trademarks of their respective owners. Products on the front cover may be for illustration only and may not be available for sale. Food, beverages, medicines and custom orders cannot be returned. Casters supplied with the chairs in this catalog may not be suitable for all floor types. Alternative casters are available.

PRODUCTS CANNOT BE ORDERED THROUGH THIS CATALOG

The information contained in this catalog is for information purposes only and should not be used by consumers to make final buying decisions. Information is subject to change at any time without notice. This catalog is to be used as general advertising material. Latest pricing, product information, and Prop 65 warnings are included at point of sale.

Visit our website [AleraDetails.com](https://www.aleradetails.com) for the latest pricing and product information.

Modular Furniture

Create a space for the way you work.



Elevate your office space with our collection of laminate casegoods, designed to combine quality and functionality. Crafted from durable, laminate materials, our casegoods offer long-lasting resilience while maintaining a sleek, professional appearance. Available in a wide range of modern colors and finishes, these pieces seamlessly integrate into any office aesthetic, from contemporary to traditional. Versatile configurations ensure that your workspace is optimized for both style and efficiency, with customizable options to suit your unique needs. Whether you're furnishing a private office or a collaborative workspace, our laminate casegoods deliver the perfect balance of form, function, and lasting value.

Collections Featured

- Seville 03-10
- Valencia 11-21
- Open Office 22



72" L-Shaped Desk with Left Return

Shown in Modern Mahogany

Price: \$3563

Model No.	Qty	Description
ALESVRLP4824MY	1	48"W x 24"D Left Return, Full Ped, B/B/F
ALESVRS4824MY	1	48"W x 24"D Return Shell
ALESVH7236MY	1	72"W Hutch w/Doors
ALESVLF3624MY	1	Lateral File

72" L-Shaped Desk with Left Return

Shown in Gray Walnut

Price: \$3563

Model No.	Qty	Description
ALESVRLP4824WA	1	48"W x 24"D Left Return, Full Ped, B/B/F
ALESVRS4824WA	1	48"W x 24"D Return Shell
ALESVH7236WA	1	72"W Hutch w/Doors
ALESVLF3624WA	1	Lateral File



Executive Desk

Shown in Modern Mahogany

Price: \$3918

Model No.	Qty	Description
AALESVSPL7236MY	1	72"W x 36"D, Left Ped Desk, B/B/F
ALESVBR4824MY	1	48"W x 24"D Bridge
ALESVRSPC7224MY	1	72"W x 24"D Credenza w/Full Right Ped B/B/F
ALESVH7236MY	1	72"H Hutch w/Doors



Executive Desk

Shown in Gray Walnut

Price: \$3918

Model No.	Qty	Description
ALESVSPL7236WA	1	72"W x 36"D, Left Ped Desk, B/B/F
ALESVBR4824WA	1	48"W x 24"D Bridge
ALESVRSPC7224WA	1	72"W x 24"D Credenza w/Full Right Ped B/B/F
ALESVH7236WA	1	72"H Hutch w/Doors



D-Top Executive Desk

Shown in Gray Walnut

Price: \$5118

Model No.	Qty	Description
ALEVSDTBSBK	1	D-Top Table Base
ALESVBTMP7230WA	1	72" D-Top Table w/Modesty Panel
ALESVCMLF6524WA	1	Lateral File Storage w/Cabinet Doors
ALESVRSPC7224WA	1	72"W x 24"D Credenza w/Full Right Ped B/B/F
ALESVH7236WA	1	72" Hutch w/Doors
ALESVBR4824WA	1	48"W x 24"D Bridge



L-Shaped Desk with Height Adjustable Table

Shown in Weathered Oak

Price: \$4890

Model No.	Qty	Description
ALESVHT6030OK	1	60"W x 30"D Table Top
ALESVHTBSGY	1	Adjustable Height Table Base
ALESVCM6524OK	1	Storage Cabinet
ALESVMBBFOK	1	B/B/F Full Ped
ALESVMT2L7224OK	1	72" Multipurpose table
ALESVH7236OK	1	72" Hutch w/Doors



12' Modular Conference Table

Shown in Weathered Oak

Price: \$3392

Model No.	Qty	Description
ALESVCT7248MP	2	72"W x 48"D Rectangle Conference Table Top
ALESVCTBS248MP	3	Conference Table Base

Modular Furniture

SEVILLE COLLECTION



- Features metal-to-metal, cam lock connections for a reliable hold.
- 1" thick high-performance woodgrain laminate is resistant to impacts and burns.
- Adjustable glides ensure stability on uneven floors.
- Designs include full height modesty panels & pedestals.
- Products ship fully assembled unless otherwise notated.

Double Pedestal Desk
Full height pedestals left B/B/F, right F/F

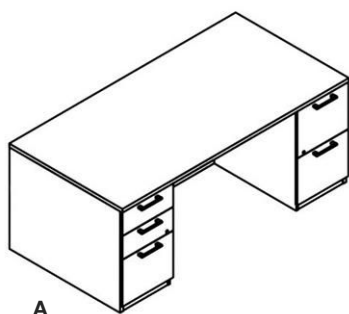

Desk Shell

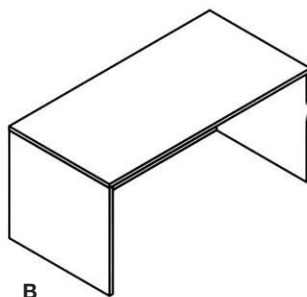

Single Pedestal Desk
Available in left or right, full height pedestal, B/B/F

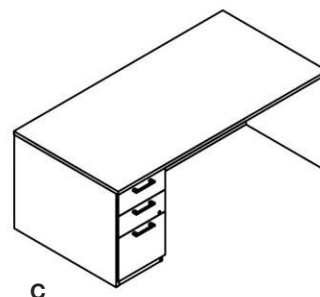

Product Title	Overall Size	Shipping Weight	Price	Warm Maple	Modern Mahogany	Weathered Oak	Gray Walnut
A Double Pedestal Desk	60"W x 30"D x 29"H	221 lbs.	\$1757	ALESVDP6030MP	ALESVDP6030MY	ALESVDP6030OK	ALESVDP6030WA
	72"W x 36"D x 29"H	257 lbs.	\$1868	ALESVDP7236MP	ALESVDP7236MY	ALESVDP7236OK	ALESVDP7236WA
B Desk Shell	60"W x 30"D x 29"H	137.9 lbs.	\$542	ALESVDS6030MP	ALESVDS6030MY	ALESVDS6030OK	ALESVDS6030WA
	72"W x 36"D x 29"H	157.7 lbs.	\$651	ALESVDS7236MP	ALESVDS7236MY	ALESVDS7236OK	ALESVDS7236WA
C Single Pedestal Desk	72"W x 36"D x 29"H	210 lbs.	\$1368	ALESVSPL7236MP (Left Ped)	ALESVSPL7236MY	ALESVSPL7236OK	ALESVSPL7236WA
				ALESVSPR7236MP (Right Ped)	ALESVSPR7236MY	ALESVSPR7236OK	ALESVSPR7236WA

Bow Front Single Ped Desk
Available in left or right, full height pedestal, B/B/F

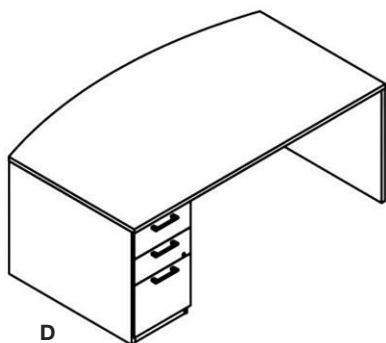

Double Pedestal Credenza
Full height pedestals left B/B/F, right F/F

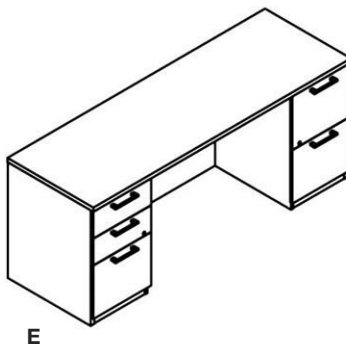

Single Pedestal Credenza
Available in left or right, full height pedestal, B/B/F

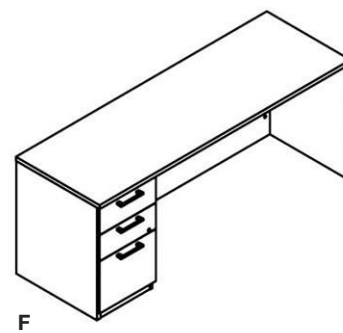

Product Title	Overall Size	Shipping Weight	Price	Warm Maple	Modern Mahogany	Weathered Oak	Gray Walnut
D Bow Front Right Ped Desk	42"W x 72"D x 29"H	240 lbs.	\$1451	ALESVB7242LPMP (Left Ped)	ALESVB7242LPMY	ALESVB7242LP0K	ALESVB7242LPWA
				ALESVB7242RPMP (Right Ped)	ALESVB7242RP0K	ALESVB7242RPWA	
E Double Pedestal Credenza	72"W x 24"D x 29"H	201 lbs.	\$1696	ALESVPC7224MP	ALESVPC7224MY	ALESVPC7224OK	ALESVPC7224WA
F Single Pedestal Credenza	72"W x 24"D x 29"H	168 lbs.	\$1211	ALESVRSPC7224MP	ALESVRSPC7224MY	ALESVRSPC7224OK	ALESVRSPC7224WA
				ALESVSPC7224MP	ALESVSPC7224MY	ALESVSPC7224OK	ALESVSPC7224WA

SEVILLE COLLECTION

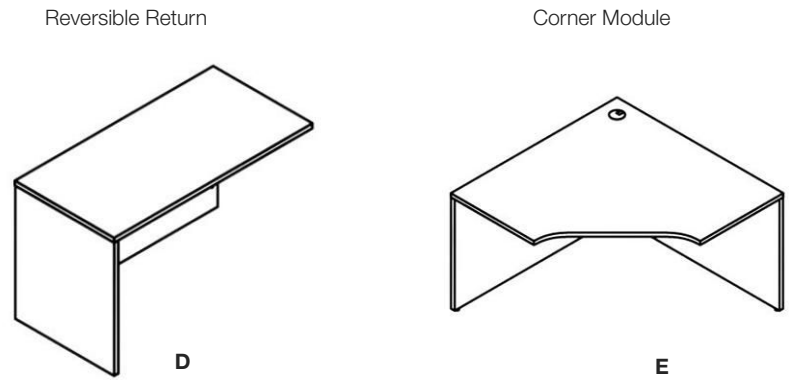
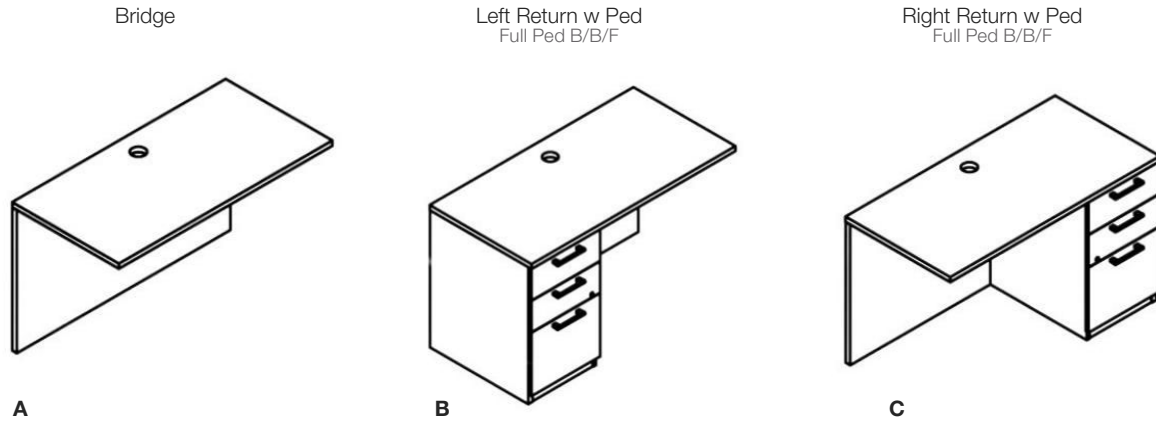

Product Title	Overall Size	Shipping Weight	Price	Warm Maple	Modern Mahogany	Weathered Oak	Gray Walnut
A Bridge	48"W x 24"D x 29"H	55 lbs.	\$469	ALESVBR4824MP	ALESVBR4824MY	ALESVBR4824OK	ALESVBR4824WA
B Left Return w/ Ped	48"W x 24"D x 29"H	135 lbs.	\$1130	ALESVRLP4824MP	ALESVRLP4824MY	ALESVRLP4824OK	ALESVRLP4824WA
C Right Return w Ped	48"W x 24"D x 29"H	135 lbs.	\$1130	ALESVRRP4824MP	ALESVRRP4824MY	ALESVRRP4824OK	ALESVRRP4824WA
D Reversible Return	48"W x 24"D x 29"H	90.5 lbs.	\$479	ALESVRS4824MP	ALESVRS4824MY	ALESVRS4824OK	ALESVRS4824WA
E Corner Module	42"W x 42"D x 29"H	112.3 lbs.	\$606	ALESVCN4224MP	ALESVCN4224MY	ALESVCN4224OK	ALESVCN4224WA

Modular Furniture

SEVILLE COLLECTION



Hutch

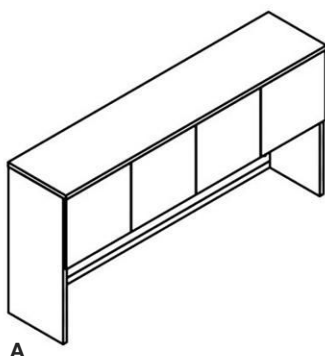

A

Multipurpose table

Available with 1 recessed leg and 1 full leg or 2 full legs. Shown with 2 full legs.

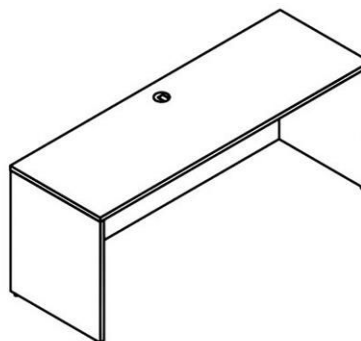

B

Return Table Desk

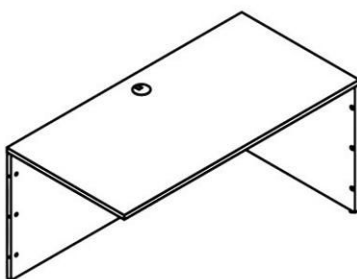

C

Wall Mounted Hutch

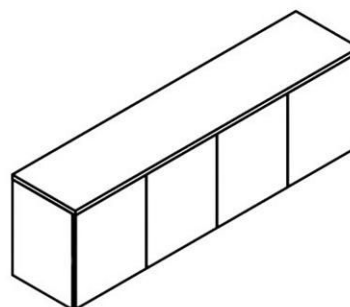

D



Product Title	Overall Size	Shipping Weight	Price	Warm Maple	Modern Mahogany	Weathered Oak	Gray Walnut
A Hutch	72"W x 16"D x 36"H	155 lbs.	\$951	ALESVH7236MP	ALESVH7236MY	ALESVH7236OK	ALESVH7236WA
B Multipurpose Table	24"W x 60"D x 29"H	97.1 lbs.	\$553	ALESVMT1L6024MP (1 Recessed Leg, 1 Full Leg)	ALESVMT1L6024MY	ALESVMT1L6024OK	ALESVMT1L6024WA
		110.9 lbs.	\$591	Return Table Desk	ALESVMT1L7224MY	ALESVMT1L7224OK	ALESVMT1L7224WA
	24"W x 72"D x 29"H	104.3 lbs.	\$553	ALESVMT2L6024MP	ALESVMT2L6024MY	ALESVMT2L6024OK	ALESVMT2L6024WA
	118.2 lbs.	ALESVMT2L7224MP (2 Full Legs)		ALESVMT2L7224MY	ALESVMT2L7224OK	ALESVMT2L7224WA	
C Return Table Desk	30"W x 60"D x 29"H	87.8 lbs.	\$591	ALESVR6030MP	ALESVR6030MY	ALESVR6030OK	ALESVR6030WA
D Wall Mounted Hutch	16"W x 72"D x 22"H	167.3 lbs.	\$1041	ALESVWH7216MP	ALESVWH7216MY	ALESVWH7216OK	ALESVWH7216WA

SEVILLE COLLECTION



48" Round Conference Base with Table

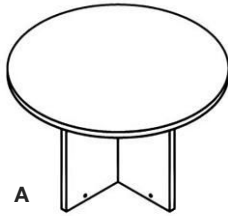

A

Conference Table Top
96" x 48"

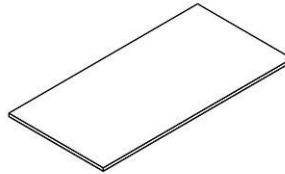

B

Conference Table Base

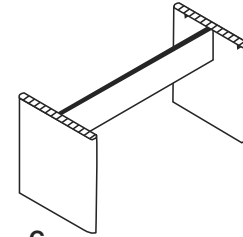

C

D-top Tabletop

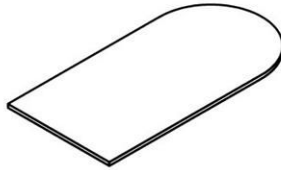

D

D-top Table with Modesty Panel

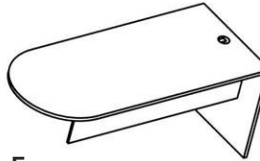

E

D-top Base

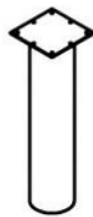

F

D-top Modesty Panel
Optional piece.

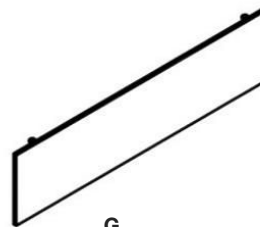

G



Product Title	Overall Size	Shipping Weight	Price	Warm Maple	Modern Mahogany	Weathered Oak	Gray Walnut	Black
A 48" Round Conference Base with Table	48"W x 48"D x 29"H	158.2 lbs.	\$887	ALESV4848MP	ALESV4848MY	ALESV4848OK	ALESV4848WA	
B Conference Table Top 96" x 48"	96"W x 48"D x 29"H	217.1 lbs.	\$622	ALESV9648MP	ALESV9648MY	ALESV9648OK	ALESV9648WA	
C Conference Table Base	29.1"W x 25.4"D x 3.4"H	50.7 lbs.	\$600	ALESV9648MPBS	ALESV9648MYBS	ALESV9648OKBS	ALESV9648WABS	
D D-top Tabletop	30"W x 60"D x 29"H	48.7 lbs.	\$325	ALESVBT6030MP	ALESVBT6030MY	ALESVBT6030OK	ALESVBT6030WA	
E D-top Table with Modesty Panel	30"W x 72"D x 29"H	87.3 lbs.	\$553	ALESVBTMP7230MP	ALESVBTMP7230MY	ALESVBTMP7230OK	ALESVBTMP7230WA	
F D-top Base	7.9"W x 7.9"D x 28.5"H	6.5 lbs.	\$181					ALESVDTBSBK
G D-top Modesty Panel	14"W x 45"D x 1"H		\$203	ALESVDTMP4514MP	ALESVDTMP4514MY	ALESVDTMP4514OK	ALESVDTMP4514WA	

SEVILLE COLLECTION



Conference Table Tops 60" & 72"
Can be used to build longer tables.

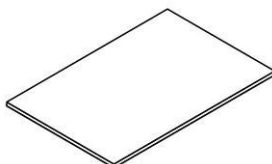

A

Conference Table Base
1-piece table top needs 2 bases,
2-piece table top needs 3 bases,
3-piece table top needs 4 bases.

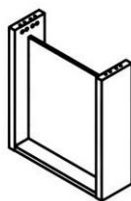

B

Racetrack Table Top, 60" & 72"
Can be used to build longer tables.

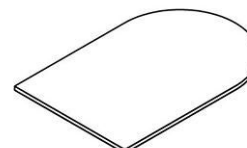

C

Height Adjustable Table 58" x 29"
Base and top sold separately.

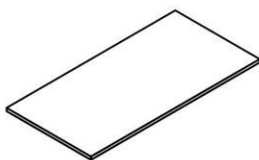

D

Height Adjustable Base
Base and top sold separately.

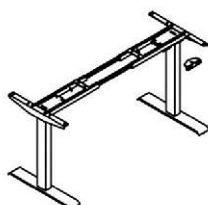

E

Training Table Top, 60" x 24"

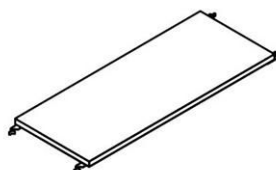

F

Training Table base

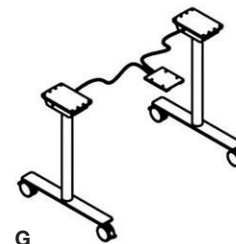

G

Table Top

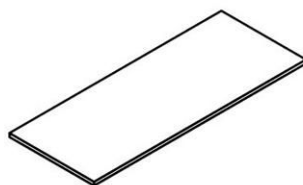

H

Metal Legs

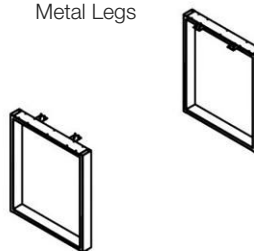

I



Product Title	Overall Size	Shipping Weight	Price	Warm Maple	Modern Mahogany	Weathered Oak	Gray Walnut	Silver	Black
A Conference Table Tops 60" & 72"	60"W x 48"D x 1.5"H	106.9 lbs.	\$686	ALESVCT6048MP	ALESVCT6048MY	ALESVCT6048OK	ALESVCT6048WA		
	72"W x 48"D x 1.5"H	127.7 lbs.	\$841	ALESVCT7248MP	ALESVCT7248MY	ALESVCT7248OK	ALESVCT7248WA		
B Conference Table Base	6"W x 24"D x 28"H	35.6 lbs.	\$458	ALESVCTBS246MP	ALESVCTBS246MY	ALESVCTBS246OK	ALESVCTBS246WA		
	8"W x 24"D x 28"H	40.2 lbs.	\$570	ALESVCTBS248MP	ALESVCTBS248MY	ALESVCTBS248OK	ALESVCTBS248WA		
C Racetrack Table Top, 60" & 72"	60"W x 48"D x 1.5"H	106.9 lbs.	\$904	ALESVCTR6048MP	ALESVCTR6048MY	ALESVCTR6048OK	ALESVCTR6048WA		
	72"W x 48"D x 1.5"H	127.7 lbs.	\$993	ALESVCTR7248MP	ALESVCTR7248MY	ALESVCTR7248OK	ALESVCTR7248WA		
D Height Adjustable Table Top 58" x 29"	58"W x 29"D x 1"H	34.8 lbs.	\$247	ALESVHT6030MP	ALESVHT6030MY	ALESVHT6030OK	ALESVHT6030WA		
E Height Adjustable Base	24- 30"W x 48-72"D x 26.6- 45.1"H	55.8 lbs	\$797					ALESVHTBSGY	
F Training Table Top, 60" x 24"	60"W x 24"D x 1"H	34.8 lbs.	\$230	ALESVTT6024MP	ALESVTT6024OK	ALESVTT6024MY	ALESVTT6024WA		
G Training Table base	3"W x 22.17"D x 28"H	28.5 lbs.	\$1000						ALESVTT6024BS
H Metal Leg Table Top	30"W x 60"D x 1"H	34.8 lbs.	\$556	ALESVMD6030MP	ALESVMD6030MY	ALESVMD6030OK	ALESVMD6030WA		
I Metal Legs	30"W x 28"D x 28.5"H	40 lbs.	\$403					ALESVMDBS30GY	

SEVILLE COLLECTION



Lateral File Cabinet

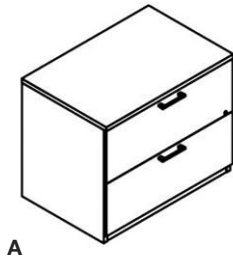

Lateral File Credenza, Left

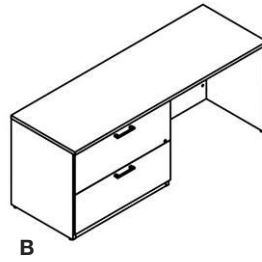

Lateral File Credenza, Right

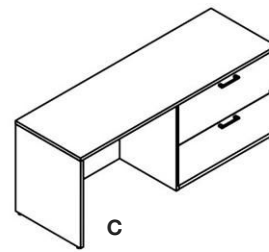

Modular Pedestal B/B/F



Modular Pedestal F/F

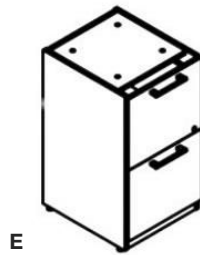

Modular Lateral File

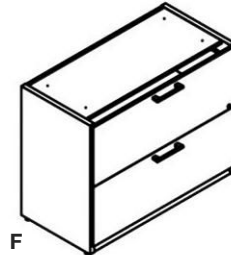

Mobile Pedestal



Bookcase, 2 adjustable shelves

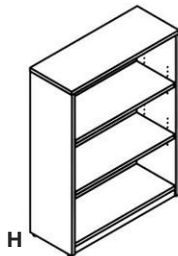

Bookcase 4 Adjustable Shelves

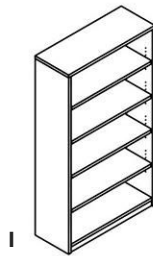

Storage Cabinet with Lateral Files

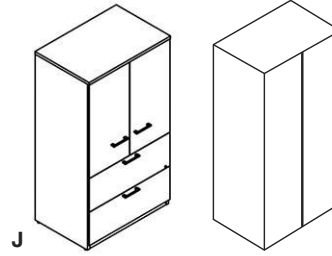

Product Title	Overall Size	Shipping Weight	Price	Warm Maple	Modern Mahogany	Weathered Oak	Gray Walnut
A Lateral File Cabinet	24"W x 72"D x 29"H	166.8 lbs.	\$1223	ALESVLF3624MP	ALESVLF3624MY	ALESVLF3624OK	ALESVLF3624WA
B Lateral File Credenza, Left	72"W x 24"D x 29"H	325.2 lbs.	\$1424	ALESVLFCL7224MP	ALESVLFCL7224MY	ALESVLFCL7224OK	ALESVLFCL7224WA
C Lateral File Credenza, Right	72"W x 24"D x 29"H	352.2 lbs.	\$1425	ALESVLCR7224MP	ALESVLCR7224MY	ALESVLCR7224OK	ALESVLCR7224WA
D Modular Pedestal B/B/F	18"W x 15"D x 28"H	62.3 lbs.	\$816	ALESVMBBFMP	ALESVMBBFMY	ALESVMBBFOK	ALESVMBBFWA
E Modular Pedestal F/F	18"W x 15"D x 28"H	62.2 lbs.	\$709	ALESVMFFMP	ALESVMFFMY	ALESVMFFOK	ALESVMFFWA
F Modular Lateral File	18"W x 36"D x 28"H	124.5 lbs.	\$825	ALESVMLF3618MP	ALESVMLF3618MY	ALESVMLF3618OK	ALESVMLF3618WA
G Mobile Pedestal B/B/F	15"W x 18"D x 27"H	82 lbs.	\$866	ALESVMPBBFMP	ALESVMPBBFMY	ALESVMPBBFOK	ALESVMPBBFWA
H Bookcase, 2 adjustable shelves	14"W x 36"D x 48"H	116.6 lbs.	\$734	ALESVBC4814MP	ALESVBC4814MY	ALESVBC4814OK	ALESVBC4814WA
I Bookcase 4 Adjustable Shelves	36"W x 14"D x 65"H	163.9 lbs.	\$859	ALESVBC6536MP	ALESVBC6536MY	ALESVBC6536OK	ALESVBC6536WA
J Storage Cabinet with Lateral Files	24"W x 36"D x 73"H	315.4 lbs	\$1753	ALESVCM6524MP	ALESVCM6524MY	ALESVCM6524OK	ALESVCM6524WA
	24"W x 36"D x 73"H	345 lbs.	\$1753	ALESVCM6524MP	ALESVCM6524MY	ALESVCM6524OK	ALESVCM6524WA

Modular Furniture

VALENCIA™ SERIES

- Contemporary design; woodgrain laminate construction.
- Commercial grade laminate work surfaces and panels are water, scratch, and stain resistant.
- Tight, dowel and cam-lock assembly.
- Matching components with Valencia and Open Office typicals.

Valencia Desking



Executive Workstation with Storage

Shown in Gray

Price: \$3,828

Model No.	Qty	Description
ALEVA636632GY	2	Valencia Series Bookcase
ALEVA257224GY	1	Valencia Series Credenza Shell
ALEVA287215GY	1	Valencia Series Hutch with Door
ALEVA513622GY	2	Valencia Series Lateral File
ALEVA217236GY	1	Valencia Series Straight Front Desk Shell



VALENCIA™ SERIES

- Management office solutions featuring durable woodgrain laminate finishes.
- Commercial-grade 1" thick worksurface and side panels are water, scratch and dent resistant, featuring a protective edge banding.
- Leveling glides compensate for uneven floors.

72" Double Ped Desk

71"W x 36"D x 29.6"H

Shown in Mahogany

Price: \$1,360

Model No.	Qty	Description
ALEVA312414MY	1	Center Drawer
ALEVA532822MY	1	Full Pedestal B/B/F
ALEVA542822MY	1	Full Pedestal F/F
ALEVA217236MY	1	71" Straight Front Desk Shell



72" L Shape Desk

71"W x 84"D x 29.6"H

Shown in Modern Walnut

Price: \$1,619

Model No.	Qty	Description
ALEVA312414WA	1	Center Drawer
ALEVA532822WA	1	Full Pedestal B/B/F
ALEVA542822WA	1	Full Pedestal F/F
ALEVA354824WA	1	Reversible Return/Bridge Shell
ALEVA217236WA	1	Straight Front Desk Shell



72" U Shape Typical

71"W x 108"D x 29.6"H to 65"H

Shown in Medium Cherry

Price: \$2,119

Model No.	Qty	Description
ALEVA312414MC	1	Center Drawer
ALEVA257224MC	1	71" Credenza Shell
ALEVA513622MC	1	Lateral File
ALEVA287215MC	1	71" Hutch with Door
ALEVA354824MC	1	Reversible Return/Bridge Shell
ALEVA217236MC	1	71" Straight Front Desk Shell
ALEVA316614	1	Tackboard



Modular Furniture

VALENCIA™ SERIES

66" L Shape Typical

65"W x 71"D x 29.6"H to 65"H

Shown in Gray

Price: \$2,133

Model No.	Qty	Description
ALEVA542822GY	1	Full Pedestal F/F
ALEVA532822GY	1	Full Pedestal B/B/F
ALEVA287215GY	1	71"W Hutch with Door
ALEVA354224GY	1	42" Reversible Return/Bridge Shell
ALEVA216630GY	1	65" Straight Front Desk Shell
ALEVA316614	1	Tackboard



D-Top Desk w/Return

71"W x 84"D x 29.6" to 65"H

Shown in Espresso

Price: \$2,197

Model No.	Qty	Description
ALEVA277236ES	1	71" D-Top Desk
ALEVA542822ES	1	Full Pedestal F/F
ALEVA287215ES	1	71"W Hutch with Door
ALEVA572816ES	1	Mobile Pedestal B/B/F
ALEVA353624ES	1	35" Reversible Return/Bridge Shell
ALEVA316614	1	Tackboard



Reception Desk w/Return

71"W x 59"D x 29.5" to 42.5"H

Shown in Mahogany

Price: \$1,982

Model No.	Qty	Description
ALEVA312414MY	1	Center Drawer
ALEVA542822MY	1	Full Pedestal F/F
ALEVA532822MC	1	Full Pedestal B/B/F
ALEVA327236MY	1	71" Reception Desk with Transaction Counter
ALEVA324424MY	1	44" Reversible Reception Return



OPEN OFFICE DESK SERIES

- Modular light scale desking for the contemporary open-plan office.
- Durable steel frame adjusts to fit standard 48" to 72" wide work surfaces.
- Scratch, dent and spill resistant thermally fused laminate work surfaces.
- Low-profile, practical storage solutions fit in compact spaces.
- Mix-and-match components and color options combine to offer flexible design choices.

60" Desk w/Low Credenza

59.5" W x 69"D x 22.9"-29.5"H
Shown in Medium Cherry

Price: \$1,531

Model No.	Qty	Description
ALELSTB30GR	1	Adjustable O-Leg Desk Base
ALELS583020MC	1	Low File Cabinet Credenza
ALELS593020MC	1	Low Storage Cabinet Credenza
ALETT6030CM	1	59.4"W x 29.5"D Reversible Laminate Table Top



72" L-Shape Desk with Mobile Peds

71.5"W x 71"D x 29.5"H
Shown in Medium Cherry

Price: \$1,759

Model No.	Qty	Description
ALELSTB24GR	1	Adjustable O-Leg Desk Base
ALELSRT24GR	1	Series O-Leg Return Base
ALETT7224CM	1	71.5" Reversible Laminate Table Top
ALETT4824CM	1	47.6" Reversible Laminate Table Top
ALEVABFMC	2	Valencia Series Mobile Pedestal B/F



72" Height Adjustable Desk w/Low Credenza

71"W x 69"D x 25"- 50.7"H
Shown in Espresso & White Table Top

Price: \$2,252

Model No.	Qty	Description
ALEHT3SAG	1	AdaptivErgo Sit-Stand 3-Stage Electric Height-Adjustable Table Base with Memory Control, Gray
ALELS583020ES	1	Desk Series Low File Cabinet Credenza
ALELS593020ES	1	Low Storage Cabinet Credenza
ALETT7230WG	1	Reversible Laminate Table Top



Modular Furniture

VALENCIA™ SERIES



- Configurable and versatile office suites to enhance productivity.
- Durable woodgrain laminate finishes.
- Commercial-grade 1" thick worksurface and side panels are water, scratch and dent-resistant, featuring protective edge banding.
- Matching finishes throughout the Valencia™ Series desk, bookcase, storage and conference table components.
- Leveling glides compensate for uneven floors.

Straight Front Desk 48"

47.3"W x 29.5"D x 29.6"H
Shipping Weight: 105.8 lbs.
Shown in Espresso

Price: \$324

- ALEVA214830ES
- ALEVA214830MC
- ALEVA214830MY
- ALEVA214830WA



Straight Front Desk 60"

59.1"W x 29.5"D x 29.6"H
Shipping Weight: 119.9 lbs
Shown in Espresso

Price: \$353

- ALEVA216030ES
- ALEVA216030GY
- ALEVA216030MC
- ALEVA216030MY
- ALEVA216030WA



Straight Front Desk 65"

65"W x 29.5"D x 29.6"H
Shipping Weight: 128.2 lbs.
Shown in Espresso

Price: \$363

- ALEVA216630ES
- ALEVA216630GY
- ALEVA216630MC
- ALEVA216630MY
- ALEVA216630WA



Straight Front Desk 72"

71"W x 35.5"D x 29.6" H
Shipping Weight: 149.9 lbs.
Shown in Espresso

Price: \$461

- ALEVA217236ES
- ALEVA217236GY
- ALEVA217236MC
- ALEVA217236MY
- ALEVA217236WA



Bow Front Desk 72"

71"W x 41.4"D x 29.6"H
Shipping Weight: 157.3 lbs.
Shown in Espresso

Price: \$479

- ALEVA227236ES
- ALEVA227236MC
- ALEVA227236MY
- ALEVA227236WA



Reversible Return/Bridge Shell 36"

35" W x 23.6"D x 29.5"H
Shipping Weight: 65.3 lbs.
Shown in Espresso

Price: \$215

- ALEVA353624ES
- ALEVA353624MC
- ALEVA353624MY
- ALEVA353624WA



Reversible Return/Bridge Shell 42"

42" W x 23.6"D x 29.5"H
Shipping Weight: 73.5 lbs.
Shown in Espresso

Price: \$245

- ALEVA354224ES
- ALEVA354224GY
- ALEVA354224MC
- ALEVA354224MY
- ALEVA354224WA



Reversible Return/Bridge Shell 48"

47.3" W x 23.6"D x 29.5"H
Shipping Weight: 82 lbs.
Shown in Espresso

Price: \$259

- ALEVA354824ES
- ALEVA354824GY
- ALEVA354824MC
- ALEVA354824MY
- ALEVA354824WA

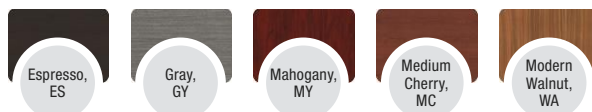

VALENCIA™ SERIES



Credenza Shell 66"

65"W x 23.6"D x 29.5"H
Shipping Weight: 109 lbs.
Shown in Espresso

Price: \$336

- ALEVA256624ES
- ALEVA256624MC
- ALEVA256624MY
- ALEVA256624WA



D-Top Desk 72"

71"W x 35.5"D x 29.6"H
Shipping Weight: 111.1 lbs
Shown in Espresso

Price: \$444

- ALEVA277236ES
- ALEVA277236MC
- ALEVA277236MY



Hutch with doors 66"

64.8"W x 15"D x 35.4"H
Shipping Weight: 139 lbs.
Shown in Espresso

Price: \$512

- ALEVA286615ES
- ALEVA286615MC
- ALEVA286615MY
- ALEVA286615WA



Glass Door Set for Hutch

17"W x 16"H
Shipping Weight: 25.1 lbs.
Shown in Clear

Price: \$216/ST

ALEVA301730



Credenza Shell 60"

59.1"W x 23.6"D x 29.5"H
Shipping Weight: 101.8 lbs.
Shown in Espresso

Price: \$310

- ALEVA256024ES
- ALEVA256024MC
- ALEVA256024MY
- ALEVA256024WA



Credenza Shell 72"

70.9"W x 23.6"D x 29.5"H
Shipping Weight: 115.5 lbs.
Shown in Espresso

Price: \$351

- ALEVA257224ES
- ALEVA257224GY
- ALEVA257224MC
- ALEVA257224MY
- ALEVA257224WA



Hutch with doors 60"

58.9"W x 15"D x 35.4"H
Shipping Weight: 121.7 lbs.
Shown in Espresso

Price: \$445

- ALEVA286015ES
- ALEVA286015MC
- ALEVA286015MY
- ALEVA286015WA



Hutch with doors 72"

70.6"W x 15"D x 35.4"H
Shipping Weight: 150 lbs.
Shown in Espresso

Price: \$564

- ALEVA287215ES
- ALEVA287215GY
- ALEVA287215MC
- ALEVA287215MY
- ALEVA287215WA



Tackboard for 72/66 Hutch

62.4"W x 0.5"D x 14"H
Shipping Weight: 8.8 lbs.
Shown in Gray

Price: \$141

ALEVA316614



Modular Furniture

VALENCIA™ SERIES

Reception Desks, Pedestals

Reception Desk with Transaction Counter

71"W x 35.5"D x 29.5"H to 42.5"H
Shipping Weight: 201.5 lbs.
Shown in Espresso

Price: \$731

- ALEVA327236ES
- ALEVA327236MC
- ALEVA327236MY
- ALEVA327236WA



Reversible Reception Return

44.1"W x 23.6"D x 41.5"H
Shipping Weight: 95.9 lbs.
Shown in Espresso

Price: \$352

- ALEVA324424ES
- ALEVA324424MC
- ALEVA324424MY



File Organizer

15.8"W x 9.9"D x 10.9"H
Shipping Weight: 15.2 lbs.
Shown in Espresso

Price: \$71

- ALEVA316012ES
- ALEVA316012MC
- ALEVA316012MY



Full Pedestal Box/Box/File

15.6"W x 20.5"D x 28.5"H
Shipping Weight: 73.9 lbs.
To be used under a worksurface.
Shown in Espresso

Price: \$415

- ALEVA532822ES
- ALEVA532822GY
- ALEVA532822MC
- ALEVA532822MY
- ALEVA532822WA



Full Pedestal File/File

15.6"W x 20.5"D x 28.5"H
Shipping Weight: 73.3 lbs.
To be used under a worksurface.
Shown in Espresso

Price: \$403

- ALEVA542822ES
- ALEVA542822GY
- ALEVA542822MC
- ALEVA542822MY
- ALEVA542822WA



Hanging Pedestal Box/File

15.6"W x 20.5"D x 19.3"H
Shipping Weight: 51.7 lbs.
Not freestanding, attaches under worksurface.
Shown in Espresso

Price: \$287

- ALEVA552222ES
- ALEVA552222MC
- ALEVA552222MY
- ALEVA552222WA



VALENCIA™ SERIES



Mobile Workstation 42"

41.4"W x 23.6"D x 30"H
Shipping Weight: 99 lbs.
Shown in Espresso

Price: \$421

- ALEVA204224ES
- ALEVA204224MC
- ALEVA204224MY
- ALEVA204224WA



Center Drawer

24.5"W x 15"D x 2"H
Shipping Weight: 8.8 lbs.
Shown in Espresso

Price: \$81

- ALEVA312414WA
- ALEVA312414ES
- ALEVA312414MC
- ALEVA312414MY



Mobile Pedestal Box/Box/File

15.9"W x 20.5"D x 28.4"H
Shipping Weight: 76.1 lbs.
Shown in Espresso

Price: \$430

- ALEVA572816ES
- ALEVA572816GY
- ALEVA572816MC
- ALEVA572816MY
- ALEVA572816WA



Underdesk Keyboard/Mouse Shelf

Shipping Weight: 12.4 lbs.
Color: Black

Price: \$61

ALEVA312812BK



Mobile Pedestal Box/File

15.9"W x 19.1"D x 22.9"H
Shipping Weight: 55 lbs.
Shown in Espresso

Price: \$376

- ALEVABFES
- ALEVABFMC
- ALEVABFWA
- ALEVBFMY



Lock Replacement

Each order received for multiple locks will be shipped keyed-alike. Each lock comes with 2 keys.

Shipping Weight: 5.9 lbs.

Color: Silver

Price: \$23

ALEVA501111



Mobile Pedestal File/File

15.4"D x 20"W x 26.6"H
Shipping Weight: 67.1 lbs.
Shown in Espresso

Price: \$416

- ALEVA582816ES
- ALEVA582816MC
- ALEVA582816MY
- ALEVA582816WA



Under Cabinet Lamp

24" LED strip light comes with 3 brightness settings, mounting hardware and 70" long cord.

Shown in Black
Shipping Weight: 1.1 lbs.

Price: \$104

ALELEDUC24B



Modular Furniture

VALENCIA™ SERIES



Storage

Lateral File

34"W x 22.8" x 29.5"H
Shipping Weight: 141.7 lbs.
Shown in Espresso

Price: \$697

- ALEVA513622ES
- ALEVA513622GY
- ALEVA513622MC
- ALEVA513622MY
- ALEVA513622WA



Storage Cabinet

34.1"W x 22.8"D x 29.5"H
Shipping Weight: 114.4 lbs.
Shown in Espresso

Price: \$432

- ALEVA613622ES
- ALEVA613622MC
- ALEVA613622MY
- ALEVA613622WA



Bookcase 2 Shelf

31.8"W x 14"D x 29.5"H
Shipping Weight: 62.7 lbs.
Shown in Espresso

Price: \$245

- ALEVA633032ES
- ALEVA633032MC
- ALEVA633032MY
- ALEVA633032WA



Bookcase 3 Shelf

31.8"H x 14"D x 39.4"H
Shipping Weight: 81.4 lbs.
Shown in Modern Walnut

Price: \$292

- ALEVA634432ES
- ALEVA634432MC
- ALEVA634432MY
- ALEVA634432WA



Bookcase 4 Shelf

31.8"W x 14"D x 54.9"H
Shipping Weight: 108 lbs.
Shown in Modern Walnut

Price: \$351

- ALEVA635632ES
- ALEVA635632MC
- ALEVA635632MY
- ALEVA635632WA



Bookcase 5 Shelf

31.8"W x 14"D x 64.8"H
Shipping Weight: 128.8 lbs.
Shown in Mahogany

Price: \$399

- ALEVA636632ES
- ALEVA636632GY
- ALEVA636632MC
- ALEVA636632MY
- ALEVA636632WA



Bookcase 6 Shelf

31.8"W x 14"D x 80.3"H
Shipping Weight: 150.7 lbs.
Shown in Mahogany

Price: \$498

- ALEVA638232ES
- ALEVA638232MC
- ALEVA638232MY
- ALEVA638232WA



Bookcase 7 Shelf

35.6"W x 11.8"D x 83.9"H
Shipping Weight: 135.6 lbs.
Shown in Mahogany

Price: \$632

- ALEVA78436MC
- ALEVA78436MY



Narrow 6 Shelf

11.8"W x 11.8"D x 71.7"H
Shipping Weight: 61.7 lbs.
Shown in Medium Cherry

Price: \$318

- ALEVA67212MC
- ALEVA67212MY



Wardrobe

11.9"W x 22.8"D x 65"H
Shipping Weight: 94.8 lbs.
Shown in Medium Cherry

Price: \$385

- ALEVA621224ES
- ALEVA621224MC
- ALEVA621224WA



VALENCIA™ SERIES

- Matching finishes with Valencia Series Modular Desking components.
- Durable woodgrain laminate top is water, scratch and dent-resistant with protective 3 mm edge banding.
- Leveling glides compensate for uneven floors.

Round Conference Table

42" Diameter x 29.5"H
Shipping Weight: 79.2 lbs.
Shown in Espresso

Price: \$408

- ALEVA7142ES
- ALEVA7142MC
- ALEVA7142MY
- ALEVA7142WA



Conference Table 96"

94.5"W x 41.4"D x 29.5"H
Shipping Weight: 195 lbs.
Shown in Espresso

Price: \$715

- ALEVA719642ES
- ALEVA719642MC
- ALEVA719642MY
- ALEVA719642WA



Conference Table 72"

70.9"W x 41.4"D x 29.5"H
Shipping Weight: 159 lbs.
Shown in Espresso

Price: \$583

- ALEVA717242ES
- ALEVA717242MC
- ALEVA717242MY
- ALEVA717242WA



Small Rectangle Occasional Table

23.6"W x 20"D x 20.4"H
Shipping Weight: 26.4 lbs.
Shown in Black

Price: \$179

- ALEVA7520BK
- ALEVA7520MY



Rectangle Occasional Table

47.3"W x 19.1"D x 16.4"H
Shipping Weight: 41.6 lbs.
Shown in Black

Price: \$239

- ALEVA7548BK
- ALEVA7548MY



Modular Furniture

- Take your pick. Multiple sizes and colors to create your own unique desk, table or workstation.
- Reversible table tops have a different color and pattern on each side with coordinating dark gray edge banding.
- Use with Alera® bases to create height adjustable workstations, training tables, collaborative spaces or standard desks.
- Durable laminate is water, scratch, and dent-resistant.
- Coordinating colors with Alera® Valencia™ and Open Office Suites.
- Commercial grade, 1" thick top.
- Table tops and bases sold and shipped separately— order both.

Reversible Laminate Top 48 x 24

Overall Size: 47.6"W x 23.6"D
 Top Material: Woodgrain Laminate
 Shipping Weight: 33 lbs.
 Shown in Cherry/Mahogany

Price: \$155 EA

- ALETT4824CM
- ALETT4824EW
- ALETT4824WG



Reversible Laminate Top 60 x 30

Overall Size: 59.4"D x 29.5"W
 Top Material: Woodgrain Laminate
 Shipping Weight: 45.1 lbs.
 Shown in White/Gray

Price: \$224 EA

- ALETT6030CM
- ALETT6030EW
- ALETT6030WG

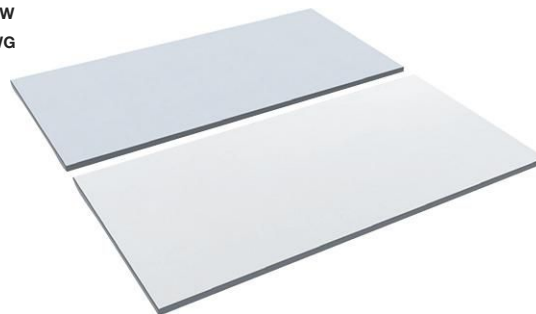

Reversible Laminate Top 60 x 24

Overall Size: 59.5"D x 23.6"W
 Top Material: Woodgrain Laminate
 Shipping Weight: 40 lbs.
 Shown in Espresso/Walnut

Price: \$177 EA

- ALETT6024CM
- ALETT6024EW
- ALETT6024WG



Reversible Laminate Top 72 x 30

Overall Size: 71.5"W x 29.5"D
 Top Material: Woodgrain Laminate
 Shipping Weight: 57.3 lbs.
 Shown in Espresso/Walnut

Price: \$273 EA

- ALETT7230CM
- ALETT7230EW
- ALETT7230WG



Reversible Laminate Top 72 x 24

Overall Size: 71.5"W x 23.6"D
 Top Material: Woodgrain Laminate
 Shipping Weight: 47.4 lbs.
 Shown in Cherry/Mahogany

Price: \$206 EA

- ALETT7224CM
- ALETT7224EW
- ALETT7224WG



OPEN OFFICE DESK SERIES



- Modular light scale desking for the contemporary open-plan office.
- Durable o-leg steel base frame adjusts to fit standard 48" to 72" wide work surfaces.
- Scratch, dent and spill resistant thermally fused laminate work surfaces.
- Frames and credenzas have leveling glides to compensate for uneven floors.
- Mix-and-match components and color options combine to offer flexible design choices.

O-Leg Return Base

36" to 70.8"W x 23.4"D x 28.5"H
 Color: Silver
 Material: Steel
 Shipping Weight: 20.2 lbs.
Price: \$235

ALELSRT24GR

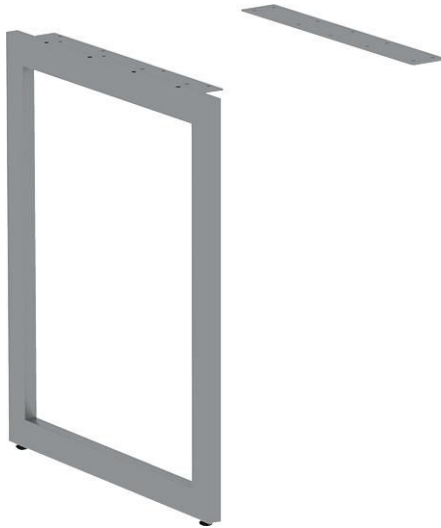

Adjustable O-Leg Desk Base

47.3" to 70.8"W x 23.6"D x 28.5"H
 Color: Silver
 Material: Steel
 Shipping Weight: 55 lbs.
 Compatible Tops: 48"-72"W x 24"D
Price: \$411

ALELSB24GR



Adjustable O-Leg Desk Base

47.3" to 70.8"W x 29.5"D x 28.5"H
 Color: Silver
 Material: Steel
 Shipping Weight: 59.4 lbs.
 Compatible Tops: 48"-72"W x 30"D
Price: \$448

ALELSB30GR



Low File Cabinet Credenza

29.5"W x 19.1"D x 22.9"H
 Shown in Espresso
 Shipping Weight: 94.6 lbs.
Price: \$597

- ALELS583020ES**
- ALELS583020MC**
- ALELS583020MY**
- ALELS583020WA**



Low Storage Cabinet Credenza

29.5"W x 19.1"D x 22.8"H
 Shown in Espresso
 Shipping Weight: 64.9 lbs.
Price: \$262

- ALELS593020ES**
- ALELS593020MY**
- ALELS593020MC**
- ALELS593020WA**



Ergonomics

The crossroads of comfort, productivity in the workplace.



Maximize your workspace with our ergonomic furniture and accessories, designed to support both your well-being and your work performance. Engineered for comfort, flexibility, and adaptability, these products are crafted to encourage natural movement, reduce strain, and enhance productivity throughout your day. With customizable features that allow for easy transitions between sitting and standing, as well as personalized adjustments for posture and support, our ergonomic solutions promote a more dynamic work environment. Whether you're collaborating with a team or working solo, our ergonomic furniture adapts to your rhythm, helping you stay focused, energized, and productive.

- Sit to Stand Desks & Accessories 24-26
- Backrest & Footrest 27
- Chair Mats 28

ADJUSTABLE HEIGHT TABLES & DESKS

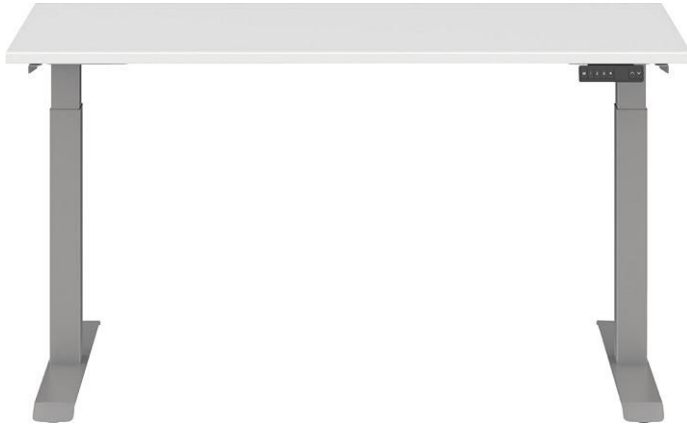

AdaptivErgo Sit-Stand Three-Stage Electric Height-Adjustable Table with Memory Control

Overall Size: 60"W x 24"D x 30" to 49"H
 Weight Capacity: Supports up to 250 lbs evenly distributed
 Color: White/Gray
 Top Material: Laminate
 Base/Leg Material: Steel
 Shipping Weight: 114.6 lb

ALEHT3SAGBD **\$1225** EA



AdaptivErgo Sit-Stand 3-Stage Electric Height-Adjustable Table Base with Memory Control

Table tops and bases are sold separately, order both
 Overall Size: 48.1"W x 24.4"D x 25" to 50.7"H
 Weight Capacity: Supports up to 285 lbs evenly distributed
 Base/Leg Material: Steel
 Shipping Weight: 70.4 lb

ALEHT3SAB **\$1120** EA Black
ALEHT3SAG **\$1120** EA Gray



AdaptivErgo Sit-Stand Two-Stage Electric Height-Adjustable Table Base

Table tops and bases are sold separately, order both
 Overall Size: 48.1"W x 24.4"D x 27.5" to 47.2"H
 Weight Capacity: Supports up to 250 lbs evenly distributed
 Base/Leg Material: Steel
 Shipping Weight: 63.8 lb

ALEHT2SSB **\$959** EA Black
ALEHT2SSG **\$959** EA Gray



AdaptivErgo Sit-Stand Pneumatic Height-Adjustable Table Base

Table tops and bases are sold separately, order both
 Overall Size: 59.1"W x 28.4"D x 26.2" to 39.6"H
 Weight Capacity: Supports up to 100 lbs evenly distributed including weight of worksurface
 Base/Leg Material: Steel
 Shipping Weight: 59.5 lb

ALEHTPN1B **\$951** EA Black
ALEHTPN1G **\$951** EA Gray

Tables

- Take your pick. Multiple sizes and colors to create your own unique desk, table or workstation.
- Reversible table tops have a different color and pattern on each side with coordinating dark gray edge banding.
- Use with Alera® bases to create height adjustable workstations, training tables, collaborative spaces or standard desks.
- Durable laminate is water, scratch, and dent-resistant.
- Coordinating colors with Alera® Valencia™ and Open Office Suites.
- Commercial grade, 1" thick top.
- Table tops and bases sold and shipped separately— order both.

Reversible Laminate Top 48 x 24

Overall Size: 47.6"W x 23.6"D
 Top Material: Woodgrain Laminate
 Shipping Weight: 33 lbs.
 Shown in Cherry/Mahogany

Price: \$155 EA

- ALETT4824CM
- ALETT4824EW
- ALETT4824WG



Reversible Laminate Top 60 x 30

Overall Size: 59.4"D x 29.5"W
 Top Material: Woodgrain Laminate
 Shipping Weight: 45.1 lbs.
 Shown in White/Gray

Price: \$224 EA

- ALETT6030CM
- ALETT6030EW
- ALETT6030WG

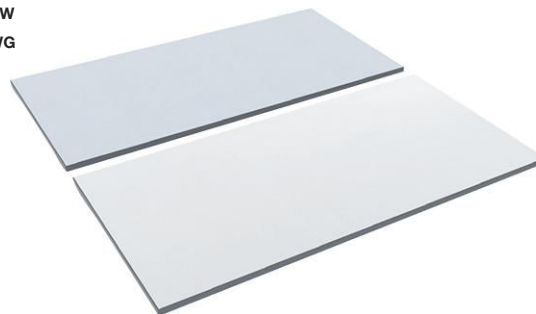

Reversible Laminate Top 60 x 24

Overall Size: 59.5"D x 23.6"W
 Top Material: Woodgrain Laminate
 Shipping Weight: 40 lbs.
 Shown in Espresso/Walnut

Price: \$177 EA

- ALETT6024CM
- ALETT6024EW
- ALETT6024WG



Reversible Laminate Top 72 x 30

Overall Size: 71.5"W x 29.5"D
 Top Material: Woodgrain Laminate
 Shipping Weight: 57.3 lbs.
 Shown in Espresso/Walnut

Price: \$273 EA

- ALETT7230CM
- ALETT7230EW
- ALETT7230WG



Reversible Laminate Top 72 x 24

Overall Size: 71.5"W x 23.6"D
 Top Material: Woodgrain Laminate
 Shipping Weight: 47.4 lbs.
 Shown in Cherry/Mahogany

Price: \$206 EA

- ALETT7224CM
- ALETT7224EW
- ALETT7224WG



ACCESSORIES

Smooth movement slide-out tray puts your keyboard right where you need it, under your desk for improved ergonomics. Easy to install with sturdy metal clamps on any surface up to 1.5" thick. Impact resistant, plastic tray fits most standard and ergonomic keyboards. A great choice when under-desk cross bars, hardware, or other obstructions make permanent mount keyboard trays impossible to install. No screw installation does not damage the work surface.

AdaptivErgo Clamp-On Keyboard Tray

Overall Size: 30.7"W x 13"D
 Color: Black
 Material: Plastic
 Shipping Weight: 6.4 lb

ALEKBT1B \$99 EA



Casters provide flexibility to bring Sit-to-Stand workstations anywhere in your office, conference or huddle spaces. Move and reposition your Alera® Height-Adjustable Table Bases with these convenient casters. Easy to attach locking casters.

Casters for Height-Adjustable Table Base

Overall Size: 2" Wheel
 Color: Black
 Material: Nylon
 Shipping Weight: 3.1 lb

ALEHT3004 \$38 ST

PRIVACY PANELS & SCREENS

- Semi-transparent frosted panel creates a private desk area while allowing light to filter through.
- Lightweight, waterproof and impact-resistant.
- Strong 1-7/8" wide metal brackets anchor panel securely to desktops up to 1" thick.
- Clip-on assembly with no tools required.

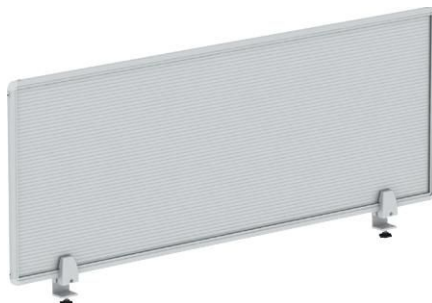

Overall Size: 47"W x 0.5"D x 18"H
 Color: Silver/Clear
 Material: Polycarbonate & Metal
 Shipping Weight: 7.92 lb
ALEPP4718 \$173 EA



Overall Size: 65"W x 0.5"D x 18"H
 Color: Silver/Clear
 Material: Polycarbonate & Metal
 Shipping Weight: 8.8 lb
ALEPP6518 \$291 EA

ADAPTIVERGO ANTI-FATIGUE MAT

Encourages proper ergonomics and reduces fatigue with this cushioned standing mat. Beveled edge lays flat on the floor to reduce trip hazards. PU-foam provides excellent cushioning while ensuring long-lasting resiliency. Ideal for use at sit-to-stand workstations, service counters, breakrooms, or wherever standing is required. Top surface features a molded grid pattern for enhanced traction. Combine with Alera® AdaptivErgo™ Height Adjustable Tables for even more ergonomic benefits with your sit-to-stand workstations. Easy to clean—just shake loose any captured debris and wipe down.



Overall Size: 19.4"W x 33.2"D x 0.7"H
 Color: Black
 Material: PU Foam
 Backing Material: Vinyl
 Shipping Weight: 6.1 lb
ALEAE23AFM \$125 EA

Ergonomics

Backrest

COOLING GEL MEMORY FOAM BACKREST

Soft, resilient memory foam cushion is pressure sensitive to help relieve stress points. Smart gel-cooling layer helps provides longer lasting cooling by dissipating heat. Long-lasting, fade-resistant fabric cover. Washable.



Color: Black
Exterior/Surface Material: Fabric
Interior/Fill Material: Cooling Gel & Memory Foam
Shipping Weight: 3.7 lb
ALECGC411 **\$72 EA**

COOLING GEL MEMORY FOAM SEAT CUSHION

Soft and resilient, pressure-sensitive memory-foam core. Heat-dissipating, cooling gel layer surrounding the memory foam core. Long-lasting, fade-resistant fabric cover. Non-slip under-cushion cover surface.



Color: Black
Exterior/Surface Material: Fabric
Interior/Fill Material: Cooling Gel & Memory Foam
Shipping Weight: 4.5 lb
ALECGC511 **\$91 EA**

MESH BACKREST

Ergonomically designed stretched mesh backrest supports the lower back. Breathable mesh fabric keeps the back cool and supported. Adjustable elastic straps secures backrest in place. Contoured shape and curves to keep the back in alignment. Great with office chairs, car seats, or in the home.



Color: Black
Exterior/Surface Material: Fabric Mesh
Shipping Weight: 1.1 lb
ALEBR118 **\$47 EA**

Footrests

ERGO TILT FOOTREST

Tilting footrest for proper ergonomic alignment. Clever foot adjustable tilt mechanism rolls back and forth for your ideal angle from 0 to 20 degrees. Ribbed surface prevents feet from slipping.



Overall Size: 13.8"W x 17.8"D x 3.4" to 5.1"H
Color: Black
Material: Plastic
Shipping Weight: 3.4 lb
ALEFS312 **\$43 EA**

SOFT CUSHIONED ERGONOMIC FOOTREST

Provides precise ergonomic foot support for any user. Comfortable cushioned footrest helps reduce strain on the feet. Non-slip, anti-fatigue cushioned mat.



Overall Size: 14"W x 19.6"D x 3.8" to 7.5"H
Color: Black
Material: Plastic
Shipping Weight: 6.4 lb
ALEFS112 **\$60 EA**

RELAXING ADJUSTABLE FOOTREST

Provides precise ergonomic foot support for any user. Designed with roller surface bumps to both help massage tired feet and keep your feet from slipping. Three tilt positions from 20 to 70 degrees and three height-adjustable positions.



Overall Size: 13.8"W x 17.8"D x 4.5" to 6.8"H
Color: Black
Material: Plastic
Shipping Weight: 4.7 lb
ALEFS212 **\$48 EA**

Occasional

OCCASIONAL USE STUDDED CHAIR MAT FOR FLAT PILE CARPET

Color: Clear
Material: Vinyl
Style: Lipped

Overall Size: 36"W x 48"D
Shipping Weight: 9.1 lb

ALEMAT3648CFPL **\$133 EA**

Overall Size: 45"W x 53"D
Shipping Weight: 11.9 lb

ALEMAT4553CFPL **\$161 EA**



Moderate

MODERATE USE STUDDED CHAIR MAT FOR LOW PILE CARPET

Color: Clear
Material: Vinyl
Style: Lipped

Overall Size: 36"W x 48"D
Shipping Weight: 11.3 lb

ALEMAT3648CLPL **\$156 EA**

Overall Size: 45"W x 53"D
Shipping Weight: 16.1 lb

ALEMAT4553CLPL **\$172 EA**



Color: Clear
Material: Vinyl
Style: Rectangle

Overall Size: 46"W x 60"D
Shipping Weight: 15.9 lb

ALEMAT4660CFPR **\$211 EA**



Color: Clear
Material: Vinyl
Style: Rectangle

Overall Size: 46"W x 60"D
Shipping Weight: 20.2 lb

ALEMAT4660CLPR **\$227 EA**



All Day

ALL DAY USE NON-STUDDED CHAIR MAT FOR HARD FLOOR

Color: Clear
Material: Vinyl (s)Vinyl Backing
Style: Lipped

Overall Size: 36"W x 48"D
Shipping Weight: 8.9 lb

ALEMAT3648HFL **\$126 EA**

Overall Size: 45"W x 53"D
Shipping Weight: 11.7 lb

ALEMAT4553HFL **\$156 EA**



Color: Clear
Material: Vinyl
Style: Rectangle

Overall Size: 46"W x 60"D
Shipping Weight: 15.6 lb

ALEMAT4660HFR **\$196 EA**



Tables

Transform any area into a flexible gathering space.



Table Collections

- Conference 30-31
- Training 32-33
- Hospitality 34
- Folding 35-37

Our versatile collection of tables is built to foster connection, collaboration, and productivity in any workspace. Whether you're hosting team meetings, conducting training sessions, or organizing casual gatherings, our tables provide the perfect foundation for dynamic interactions. With a wide range of sizes, shapes, and configurations, these tables can be easily adapted to suit the specific needs of your environment. From sleek conference tables to modular training setups, each piece is crafted for durability and functionality, ensuring that your space supports seamless communication and efficient teamwork. Designed with flexibility in mind, our tables create an inviting atmosphere where ideas flow and teams come together to innovate, learn, and succeed.

VALENCIA™ SERIES



- Matching finishes with Valencia Series Modular Desking components.
- Durable woodgrain laminate top is water, scratch and dent-resistant with protective 3 mm edge banding.
- Leveling glides compensate for uneven floors.

Round Conference Table with Leg

Overall Size: 42" Diameter x 29.5"H
 Top Material: Textured Woodgrain Laminate
 Base/Leg Material: Textured Woodgrain Laminate
 Shipping Weight: 79.2 lb

ALEVA7142ES	\$408 EA	Espresso
ALEVA7142MC	\$408 EA	Medium Cherry
ALEVA7142MY	\$408 EA	Mahogany
ALEVA7142WA	\$408 EA	Modern Walnut



Tables

Conference Table

VALENCIA™ SERIES



- Matching finishes with Valencia Series Modular Desking components.
- Durable woodgrain laminate top is water, scratch and dent-resistant with protective 3 mm edge banding.
- Leveling glides compensate for uneven floors.

Conference Tables

Overall Size: 70.9"W x 41.4"D x 29.5"H
 Top Material: Woodgrain Laminate
 Base/Leg Material: Woodgrain Laminate

		Shipping Weight	Color
ALEVA717242ES	\$583 EA	155.8 lb	Espresso
ALEVA717242MC	\$583 EA	159.0 lb	Medium Cherry
ALEVA717242MY	\$583 EA	158.0 lb	Mahogany
ALEVA717242WA	\$583 EA	152.6 lb	Modern Walnut

Overall Size: 94.5"W x 41.4"D x 29.5"H
 Top Material: Woodgrain Laminate
 Base/Leg Material: Woodgrain Laminate

		Shipping Weight	Color
ALEVA719642ES	\$715 EA	195.5 lb	Espresso
ALEVA719642MC	\$715 EA	195.5 lb	Medium Cherry
ALEVA719642MY	\$715 EA	191.1 lb	Mahogany
ALEVA719642WA	\$715 EA	189.2 lb	Modern Walnut



TABLE TOP

- Take your pick. Multiple sizes and colors to create your own unique desk, table or workstation.
- Reversible table tops have a different color and pattern on each side with coordinating dark gray edge banding.
- Use with Alera® bases to create height adjustable workstations, training tables, collaborative spaces or standard desks.
- Durable laminate is water, scratch, and dent-resistant.
- Coordinating colors with Alera® Valencia™ and Open Office Suites.
- Commercial grade, 1" thick top.
- Table tops and bases sold and shipped separately, order both.

48"W x 24"D

Overall Size: 47.6"W x 23.6"D
 Top Material: Woodgrain Laminate
 Shipping Weight: 33 lb



ALETT4824CM	\$155 EA	Medium Cherry/Mahogany
ALETT4824EW	\$155 EA	Espresso/Walnut
ALETT4824WG	\$155 EA	White/Gray

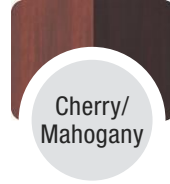

60"W x 24"D

Overall Size: 59.5"W x 23.6"D
 Top Material: Woodgrain Laminate
 Shipping Weight: 40 lb



ALETT6024CM	\$177 EA	Medium Cherry/Mahogany
ALETT6024EW	\$177 EA	Espresso/Walnut
ALETT6024WG	\$177 EA	White/Gray

60"W x 30"D

Overall Size: 59.4"W x 29.5"D
 Top Material: Woodgrain Laminate
 Shipping Weight: 45.1 lb



ALETT6030CM	\$224 EA	Medium Cherry/Mahogany
ALETT6030EW	\$224 EA	Espresso/Walnut
ALETT6030WG	\$224 EA	White/Gray

72"W x 24"D

Overall Size: 71.5"W x 23.6"D
 Top Material: Woodgrain Laminate
 Shipping Weight: 47.4 lb



ALETT7224CM	\$206 EA	Medium Cherry/Mahogany
ALETT7224EW	\$206 EA	Espresso/Walnut
ALETT7224WG	\$206 EA	White/Gray

72"W x 30"D

Overall Size: 71.5"W x 29.5"D
 Top Material: Woodgrain Laminate
 Shipping Weight: 57.3 lb



ALETT7230CM	\$273 EA	Medium Cherry/Mahogany
ALETT7230EW	\$273 EA	Espresso/Walnut
ALETT7230WG	\$273 EA	White/Gray



Tables

TABLE BASE

- Collaborate more easily -- rearrange tables in multiple configurations to suit the environment and moment.
- Durable, water, scratch and dent-resistant woodgrain laminate tops with protective 3 mm edge banding.
- Durable chip and scratch-resistant powder-coated steel bases.
- Cable-management grommets and wire troughs keep everything neat and organized.
- Included secure ganging clips allow you to join tables in any configuration.
- Tops and bases sold separately - order both.



Flip and Nest Table Base

Overall Size: 32.2"W x 23.6"D x 28.5"H
Works with Alera 36" & 48" table tops
Color: Black
Base/Leg Material: Steel
Shipping Weight: 30.0 lb

ALEVA7243BK \$407 EA



Training Table T-Leg Base

Overall Size: 24.5"W x 19.8"D x 28.5"H
Works with Alera 36" & 48" table tops
Color: Black
Base/Leg Material: Steel
Shipping Weight: 19.4 lb

ALEVA7443BK \$208 EA



Flip and Nest Table Base

Overall Size: 55.9"W x 23.6"D x 28.5"H
Works with Alera 60" & 72" table tops
Color: Black
Base/Leg Material: Steel
Shipping Weight: 34.7 lb

ALEVA7276BK \$489 EA



Training Table T-Leg Base

Overall Size: 54"W x 19.8"D x 28.5"H
Works with Alera 60" & 72" table tops
Color: Black
Base/Leg Material: Steel
Shipping Weight: 24.0 lb

ALEVA7476BK \$285 EA



Flip Training Table Base

Overall Size: 28.5"W x 19.8"D x 28.5"H
Works with Alera 36" & 48" table tops
Color: Black
Base/Leg Material: Steel
Shipping Weight: 28.81 lb

ALEVA734836BK \$278 EA



Open Office Desk Series Adjustable O-Leg Desk Base

Overall Size: 47.2" to 70.8"W x 23.6"D x 28.5"H
Works with Alera 48" to 72"W x 24"D table tops
Color: Silver
Base/Leg Material: Steel
Shipping Weight: 55.0 lb

ALELSTB24GR \$411 EA



Flip Training Table Base

Overall Size: 57.9"W x 19.8"D x 28.5"H
Works with Alera 60" & 72" table tops
Color: Black
Base/Leg Material: Steel
Shipping Weight: 43.3 lb

ALEVA737260BK \$430 EA



Open Office Desk Series Adjustable O-Leg Desk Base

Overall Size: 47.2" to 70.8"W x 29.5"D x 28.5"H
Works with Alera 48" to 72"W x 29.5"D table tops
Color: Silver
Base/Leg Material: Steel
Shipping Weight: 59.4 lb

ALELSTB30GR \$448 EA

HOSPITALITY SERIES SINGLE-COLUMN BASE



- Classic table base works great to create hospitality, meeting, conference or quick-huddle setups.
- Reinforced weighted steel base for enhanced stability and durability.
- X-shape design provides plenty of room to pull up chairs/stools.
- Compatible with Alera circle and square table tops.
- Leveling glides help to compensate for uneven floors.
- Tops and Bases Sold Separately - order both.

Base Height: 28.5"
 Weight Capacity: Supports up to 300 lbs evenly distributed
 Color: Black
 Base/Leg Material: Steel
 Shipping Weight: 25.6 lb
ALETBH283B \$331 EA



Base Height: 40.4"
 Weight Capacity: Supports up to 300 lbs evenly distributed
 Color: Black
 Base/Leg Material: Steel
 Shipping Weight: 28.4 lb
ALETBH423B \$382 EA



Table top & base shown together

REVERSIBLE LAMINATE TABLE TOP



- Take your pick. Multiple sizes and colors to create your own unique desk, table or workstation.
- Reversible table tops have a different color and pattern on each side with coordinating dark gray edge banding.
- Use with Alera® bases to create height adjustable workstations, training tables, collaborative spaces or standard desks.
- Durable laminate is water, scratch, and dent-resistant.
- Coordinating colors with Alera® Valencia™ and Open Office Suites.
- Commercial grade, 1" thick top.
- Table tops and bases sold and shipped separately—order both.



Circle Table Top

Overall Size: 35.5" Diameter
 Top Material: Woodgrain Laminate
 Shipping Weight: 28.4 lb

ALETRD36CM \$180 EA Medium Cherry/Mahogany
ALETRD36EW \$180 EA Espresso/Walnut
ALETRD36WG \$180 EA White/Gray



Table top & base shown together

Square Table Top

Overall Size: 35.4" W x 35.4" D
 Top Material: Woodgrain Laminate
 Shipping Weight: 36.3 lb

ALETTSQ36CM \$166 EA Medium Cherry/Mahogany
ALETTSQ36EW \$166 EA Espresso/Walnut
ALETTSQ36WG \$166 EA White/Gray

Tables

MULTIUSE WOOD FOLDING TABLES

- Fully finished scratch, dent and water-resistant laminate top and underside prevents warping.
- 5/8" thick top features a one-piece, steel apron and vinyl edging.
- Gravity leg-locking mechanism makes set-up quick and easy.
- Folds to 2½" thick and locks for easy transport and storage.
- 1" diameter steel legs with plastic foot caps.
- Supports up to 1,200 lbs, evenly distributed.



Round Wood Folding Table

Overall Size: 59.0" Diameter x 29.1"H
 Weight Capacity: Supports up to 1,200 lbs evenly distributed
 Color: Mahogany/Black
 Top Material: Melamine
 Base/Leg Material: Steel
 Shipping Weight: 81.8 lb

ALEFT7260DMY \$516 EA



6' Narrow Table

Overall Size: 71.9"W x 17.8"D x 29.1"H
 Weight Capacity: Supports up to 1,200 lbs evenly distributed
 Color: Mahogany
 Top Material: Laminate
 Base/Leg Material: Steel
 Shipping Weight: 41.8 lb

ALEFT727218MY \$262 EA



5' Narrow Table

Overall Size: 59.9"W x 17.8"D x 29.1"H
 Weight Capacity: Supports up to 1,200 lbs evenly distributed
 Color: Mahogany
 Top Material: Laminate
 Base/Leg Material: Steel
 Shipping Weight: 37.5 lb

ALEFT726018MY \$266 EA



6' Wood Folding Table

Overall Size: 71.9"W x 29.9"D x 29.1"H
 Weight Capacity: Supports up to 1,200 lbs evenly distributed
 Color: Mahogany
 Top Material: Laminate
 Base/Leg Material: Steel
 Shipping Weight: 60.2 lb

ALEFT727230MY \$311 EA



4' Wood Folding Table

Overall Size: 48.0"W x 23.9"D x 29.0"H
 Weight Capacity: Supports up to 1,200 lbs evenly distributed
 Color: Mahogany
 Top Material: Melamine
 Base/Leg Material: Steel
 Shipping Weight: 39.2 lb

ALEFT724824MY \$249 EA

Multiuse Folding RESIN

- Made with blow-molded high-density polyethylene top is dent-, scratch- and water-resistant.
- Lightweight and durable for easy transport.
- Can be used indoors or outdoors.
- Legs fold into underside cavity for safe storage.

Rectangular Solid Top Folding Table

Overall Size: 96"W x 30"D x 29"H
 Weight Capacity: Supports up to 350 lbs evenly distributed
 Color: Platinum
 Top Material: Blow-Molded High-Density Polyethylene
 Base/Leg Material: 1" Tubular Steel
 Shipping Weight: 49 lb

ALE65601 **\$428 EA**



Adjustable Height Folding Fold-in-Half Plastic Folding Table

Overall Size: 72"W x 29.6"D x 29.3" to 37.1"H
 Weight Capacity: Supports up to 350 lbs evenly distributed
 Color: White
 Top Material: Resin
 Base/Leg Material: Steel
 Shipping Weight: 28.2 lb

ALEPT72AHW **\$257 EA**

Rectangular Solid Top Folding Table

Overall Size: 72"W x 30"D x 29"H
 Weight Capacity: Supports up to 350 lbs evenly distributed
 Color: Platinum
 Top Material: Blow-Molded High-Density Polyethylene
 Base/Leg Material: 1" Tubular Steel
 Shipping Weight: 36 lb

ALE65600 **\$262 EA**



Rectangular Fold-in-Half Plastic Folding Table

Overall Size: 96"W x 30"D x 29.3"H
 Weight Capacity: Supports up to 350 lbs evenly distributed
 Color: White
 Top Material: Blow-Molded High-Density Polyethylene
 Base/Leg Material: Tubular Steel
 Shipping Weight: 48.5 lb

ALEPT9630G **\$375 EA**

Banquet Solid Top Folding Table

Overall Size: 48"W x 24"D x 29"H
 Weight Capacity: Supports up to 350 lbs evenly distributed
 Color: Platinum
 Top Material: Blow-Molded High-Density Polyethylene
 Base/Leg Material: 1" Tubular Steel
 Shipping Weight: 25 lb

ALE65603 **\$187 EA**



SQUARE PLASTIC FOLDING TABLE

Versatile table is perfect for indoors or outdoors. Convenient square folding table sets up quickly when extra table is needed and space is limited. Blow-molded polyethylene top is water and stain resistant; won't crack or stain.

Overall Size: 36"W x 36"D x 29.6"H
 Weight Capacity: Supports up to 600 lbs evenly distributed
 Color: White
 Top Material: Resin
 Base/Leg Material: Steel
 Shipping Weight: 27.1 lb

ALEPT36SW **\$174 EA**



Round Plastic Folding Table

Overall Size: 60" Diameter x 29.3"H
 Weight Capacity: Supports up to 600 lbs evenly distributed
 Color: White
 Top Material: Resin
 Base/Leg Material: Steel
 Shipping Weight: 55 lb

ALEPT60RW **\$374 EA**



Height-Adjustable Personal Folding Table

Overall Size: 25.6"W x 17.7"D x 19" to 28"H
 Weight Capacity: Support up to 200 lb evenly distributed
 Color: White
 Top Material: Blow-Molded High-Density Polyethylene (HDPE)
 Base/Leg Material: Metal
 Shipping Weight: 9 lb

ALE65604N **\$128 EA**



Tables

Folding Chair

ACCESSORIES

Adjustable to accommodate most styles of folding chairs/tables. Convenient steel construction cart can be used as both a folding chair cart or table cart. Adjustable U-bar keeps folding chairs from falling over during transport. U-bar is removable for table storage. Heavy-duty casters; two locking. Holds up to 600 lbs. Includes safety strap.

Chair/Table Cart

Overall Size: 20.9" x 50.8" to 72" x 43.3"
 Weight Capacity: 600 lb
 Color: Black
 Material: Steel
 Overall Material Type: Metal
 Shipping Weight: 65 lb

ALEFTCART \$597 EA



MOLDED RESIN FOLDING CHAIR

Classic chair for all occasions. Great for indoor and outdoor use. Contoured seat and back for maximum comfort. Powder coated steel frame resists corrosion and provides exceptional strength. Folds flat for compact storage. Non-marring foot caps protect surfaces.



Molded Resin Folding Chair

Seat Height: 18.2"
 Weight Capacity: Supports Up to 225 lb
 Color: White/Dark Gray
 Seat Surface Material: Resin
 Back Surface Material: Resin
 Shipping Weight: 31 lb
 4 chairs per carton

ALEFR9402 \$238 CT

ARMLESS STEEL FOLDING CHAIR

- Create additional seating in any indoor or outdoor space.
- Durable, metal base is designed to withstand heavy use.
- Covered feet prevent floor scratches and scuffs.

Seat Height: 17"
 Weight Capacity: Supports Up to 275 lb
 Seat Surface Material: Steel
 Back Surface Material: Steel
 Shipping Weight: 40.1 lb
 4 chairs per carton

ALECA941 \$171 CT Black
ALECA944 \$171 CT Taupe

PADDED, STEEL FRAME

Create additional seating in any indoor or outdoor space. Cushioned, black faux leather back and seat wipes clean. Durable, metal base is designed to withstand heavy use.



PU Padded Folding Chair

Seat Height: 17"
 Weight Capacity: Supports Up to 250 lb
 Color: Black
 Seat Surface Material: PU Leather
 Back Surface Material: PU Leather
 Shipping Weight: 45.2 lb
 4 chairs per carton

ALECA9416 \$253 CT



Reception & Lounge Seating

Creating welcoming environments and collaborative spaces.

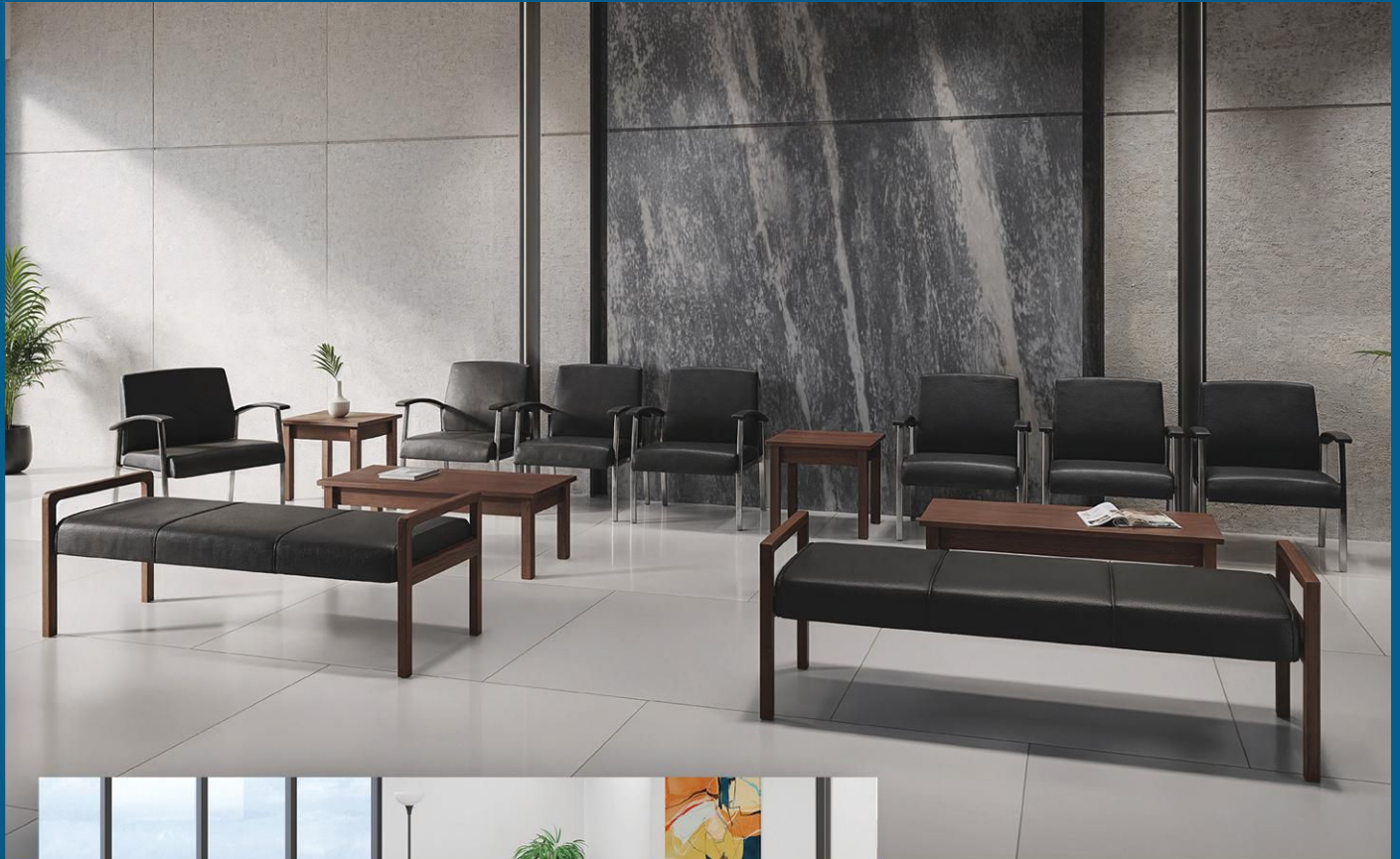

Create a welcoming atmosphere that sets the tone for your office with our Reception & Lounge Seating collection. Designed to offer both style and comfort, these pieces provide the perfect setting for visitors, clients, and employees to relax and engage. Whether you're furnishing a reception area, a casual lounge, or collaborative break spaces, our seating options combine inviting designs with premium comfort to foster relaxation and conversation. From comfortable sofas to flexible modular seating, each piece is crafted to encourage interaction, making it easy to create a space where ideas flow and connections thrive. With a focus on both aesthetics and functionality, our lounge seating solutions help transform your office into a hub of comfort and collaboration.

- Lounge Seating 39
- Sectionals 40
- Guest Chairs & Benches 41-42
- Reception Desk 43

Reception Seating

RECEPTION LOUNGE SOFA SERIES



- Classic simple lines.
- For use in any reception or lounge configurations.
- Soft black bonded leather.
- Black wood pyramid legs.



Club Chair

Overall Size: 35.4"W x 30.7"D x 32.3"H
 Weight Capacity: Supports Up to 250 lb
 Color: Black
 Material: Soft Touch Bonded Leather
 Shipping Weight: 63.3 lb

ALERL23LS10B \$927 EA



Loveseat

Overall Size: 55.5"W x 31.5"D x 33.1"H
 Weight Capacity: Supports up to 500 lbs
 Color: Black
 Material: Bonded Leather
 Shipping Weight: 75 lb

ALERL22LS10B \$1419 EA



Sofa

Overall Size: 77"W x 31.5"D x 32"H
 Weight Capacity: Supports up to 750 lbs
 Color: Black
 Material: Bonded Leather
 Shipping Weight: 110 lb

ALERL21LS10B \$1843 EA

VALENCIA™ SERIES



- Perfect for waiting rooms, guest reception, or lounge.
- Water, scratch, and dent resistant woodgrain laminate.
- Durable and protective 3mm edge banding.
- Foot leveling glides to compensate for uneven floors.

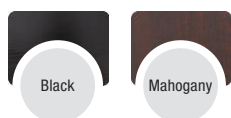

Small Occasional Table

Overall Size: 23.6"W x 20.0"D x 20.4"H
 Material: Woodgrain Laminate
 Shipping Weight: 26.4 lb

ALEVA7520BK \$179 EA Black
ALEVA7520MY \$179 EA Mahogany



Rectangle Occasional Table

Overall Size: 47.2"W x 19.1"D x 16.4"H
 Top Material: Woodgrain Laminate
 Shipping Weight: 41.6 lb

ALEVA7548BK \$239 EA Black
ALEVA7548MY \$239 EA Mahogany

QUB SERIES



- Contemporary geometric reception room sectional set can be configured in endless possibilities.
- Tufted seat design with straight backs and arms for a modern yet comfortable look.
- Powered Armless Sectional comes with one AC and two USB ports for convenient device charging.
- Silver steel frames and legs adds style.



Corner Sectional

Overall Size: 26.4"W x 26.4"D x 30.5"H
 Weight Capacity: Supports up to 275 lbs
 Color: Black
 Material: PU Leather
 Shipping Weight: 53.9 lb
ALEQB8016 📦 \$697 EA



Armless L Sectional

Overall Size: 26.4"W x 26.4"D x 30.5"H
 Weight Capacity: Supports up to 275 lbs
 Color: Black
 Material: PU Leather
 Shipping Weight: 44.5 lb
ALEQB8116 📦 \$616 EA



Ottoman

Overall Size: 26.4"W x 21.5"D x 17.5"H
 Weight Capacity: Supports up to 275 lbs
 Color: Black
 Material: PU Leather
 Shipping Weight: 32.2 lb
ALEQB8216 📦 \$531 EA



Powered Armless L Sectional

Overall Size: 26.4"W x 26.4"D x 30.5"H
 Weight Capacity: Supports up to 275 lbs
 Color: Black
 Material: PU Leather
 Shipping Weight: 45.4 lb
ALEQB8116P 📦 \$688 EA

CONFIGURATION STYLES

Reception Seating

Soft Seating

RECEPTION LOUNGE WL SERIES

- Configure with sofas and tables to create reception, lounge, conference, and waiting rooms.
- Soft bonded leather upholstery adds a modern touch and is easy-to-clean.
- Smooth wood frame adds style and durability.
- Leveling glides help compensate for uneven floors.



Black/Mahogany

Wood Loveseat

Overall Size: 44.9"W x 26.1"D x 33"H
 Weight Capacity: Supports up to 500 lbs
 Color: Black/Mahogany
 Material: Bonded Leather
 Shipping Weight: 52.1 lb

ALERL2219M **\$857 EA**

3-Seat Bench

Overall Size: 65.8"W x 22.3"D x 22.9"H
 Weight Capacity: Supports up to 750 lbs (evenly spaced).
 Color: Black/Mahogany
 Material: Bonded Leather
 Shipping Weight: 59.5 lb

ALERL2419M **\$803 EA**



3-Seat Sofa

Overall Size: 65.1"W x 26"D x 33"H
 Weight Capacity: Supports up to 750 lbs (evenly spaced).
 Color: Black/Mahogany
 Material: Bonded Leather
 Shipping Weight: 66 lb

ALERL2319M **\$1136 EA**

Black/Espresso Black/Mahogany

Guest Chair

Overall Size: 24.2"W x 24.8"D x 32.7"H
 Weight Capacity: Supports Up to 275 lb
 Material: Bonded Leather
 Shipping Weight: 29.7 lb

ALERL4319E **\$414 EA** Black/Espresso
ALERL4319M **\$414 EA** Black/Mahogany

ISPARA SERIES

Contemporary geometric styling in soft durable bonded leather. Modular armless design allows multiple chairs to be configured to create layouts that work in any room.

Armless Chair

Overall Size: 26.6"W x 30.7"D x 31.1"H
 Weight Capacity: Supports Up to 400 lb
 Color: Black/Silver
 Material: Bonded Leather
 Base/Frame Material: Steel
 Shipping Weight: 50.7 lb

ALEML8319CS \$456 EA



MADARIS SERIES

A statement guest chair that feels as good as it looks. Soft touch, black bonded leather upholstery is easy-to-clean. Padded armrests for comfort.

Bonded Leather Guest Chair with Wood Trim Leg

Overall Size: 25.4"W x 26"D x 35.6"H
 Weight Capacity: Supports Up to 275 lb
 Color: Black/Mahogany
 Material: Bonded Leather
 Base/Frame Material: Wood
 Shipping Weight: 31.5 lb

ALEMA43ALS10M \$470 EA

METALOUNGE SERIES

- Stylish and flexible design is ideal for office reception areas to waiting areas and more.
- Thickly padded seat cushion relieves pressure points at the back of the knees.
- Antimicrobial agent added to prevent the growth of germs on the upholstery surface.



High-Back Guest Chair

Overall Size: 24.6"W x 27"D x 42.9"H
 Weight Capacity: Supports Up to 275 lb
 Color: Black/Silver
 Material: PU Leather
 Base/Frame Material: Metal
 Shipping Weight: 46.8 lb

ALEML2419 \$647 EA



Bariatric Guest Chair

Overall Size: 30.5"W x 27"D x 33.5"H
 Weight Capacity: Supports Up to 450 lb
 Color: Black/Silver
 Material: PU Leather
 Base/Frame Material: Metal
 Shipping Weight: 50.1 lb

ALEML2219 \$693 EA



Mid-Back Guest Chair

Overall Size: 24.6"W x 27"D x 33.5"H
 Weight Capacity: Supports Up to 275 lb
 Color: Black/Silver
 Material: PU Leather
 Base/Frame Material: Metal
 Shipping Weight: 44.6 lb

ALEML2319 \$598 EA

Reception Seating & Desking

Soft Seating | Laminate Reception

HILDRED SERIES

Stylish guest chair provides comfort, support, and functionality. Durable, black, bonded leather back and seat. Additional comfort and support with fixed arms. Supports up to 275 lbs.



Hildred Series Guest Chair

Overall Size: 25"W x 29"D x 37.8"H
 Weight Capacity: Supports Up to 275 lb
 Color: Black/Chrome
 Material: Bonded Leather
 Base/Frame Material: Chrome
 Shipping Weight: 35.3 lb

ALEHD4319 **\$301 EA**

GENARO SERIES



- Clean, classic lines complement any office environment.
- Configure to create reception, lounge, conference, and waiting rooms.
- Thickly padded for maximum comfort.
- Durable upholstery withstands everyday use.
- Padded armrests for soft support.
- Sturdy steel sled base.



Fabric Half-Back Sled Base Guest Chair

Overall Size: 25"W x 24.8"D x 33.7"H
 Weight Capacity: Supports Up to 275 lb
 Color: Black
 Material: 100% Polyester
 Base/Frame Material: Steel
 Shipping Weight: 29.8 lb

ALERL43C11 **\$264 EA**



Faux Leather Half-Back Sled Base Guest Chair

Overall Size: 25"W x 24.8"D x 33.7"H
 Weight Capacity: Supports Up to 275 lb
 Color: Black
 Material: PU Leather
 Base/Frame Material: Steel
 Shipping Weight: 29.8 lb

ALERL43C16 **\$264 EA**

VALENCIA™ SERIES



- Ideal for transacting business or welcoming guests.
- Commercial-grade laminate work surface and side panels are water, scratch and stain resistant.
- Leveling glides help compensate for uneven floors.

Reception Desk with Bow-Shaped Transaction Counter

Overall Size: 71"W x 35.5"D x 29.5" to 42.5"H
 Material: Textured Woodgrain Laminate
 Shipping Weight: 201.5 lb

ALEVA327236ES	\$731 EA	Espresso
ALEVA327236MC	\$731 EA	Medium Cherry
ALEVA327236MY	\$731 EA	Mahogany
ALEVA327236WA	\$731 EA	Modern Walnut



Reversible Reception Return

Overall Size: 44.1"W x 23.6"D x 41.5"H
 Material: Textured Woodgrain Laminate
 Shipping Weight: 95.9 lb

ALEVA324424ES	\$352 EA	Espresso
ALEVA324424MC	\$352 EA	Medium Cherry
ALEVA324424MY	\$352 EA	Mahogany

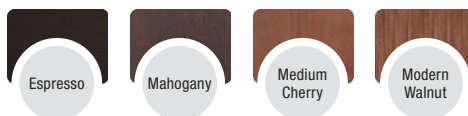

Seating

Get comfortable anywhere, any time.



Discover the perfect seating solutions for your office with our comprehensive collection of office seating, designed to support productivity and comfort in any environment. From task chairs that provide ergonomic support for long hours at the desk, to guest seating that offers both style and comfort for visitors, our seating options are tailored to meet the diverse needs of your workplace. Our range also includes versatile stools for collaborative areas or casual workspaces, offering flexible seating arrangements without compromising on comfort. Each piece is thoughtfully designed with durability, adjustability, and modern aesthetics in mind, ensuring your office is not only functional but also inviting. Whether you need a high-performance chair for focused tasks or a welcoming seat for guests, our office seating solutions provide the perfect balance of form and function.

Collections

- Elusion 46-47
- Etros 48
- Wessex 49

Application

- Big & Tall 50
- Mesh Back 51-52
- Upholstered 53
- Bonded Leather 54
- PU & Faux Leather 55-56
- Stools 57
- Interval 58
- Folding & Stacking 59
- Guest Chairs 60-61

Buying Guide Chair Features

Find the functions you're looking for using the following icons shown throughout the seating section.



Pneumatic Seat Height Adjustment

Regulates seat height relative to the floor so that feet are flat on the floor—supports better circulation.



Back Height Adjustment

Positions height of lumbar support relative to the seat cushion to alleviate back stress.



Seat Glide Mechanism

Seat or back moves forward or back, then locks in position to create the proper seat depth for better back support and circulation to legs.



Tilt Tension/Tilt Lock

Tilt allows back to recline at a 1:1 ratio to seat for a comfortable reclining position and redistribution of pressure points. Tilt tension controls the rate and ease at which the chair reclines and the lock-out tilt function keeps chair in upright position.

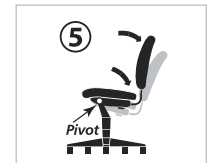

Knee Tilt

Pivot point located below front half of seat. Allows user to keep feet flat on floor while reclining. Offers increased circulation and redistribution of pressure points.

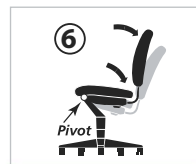

Synchronized Knee Tilt

Combines, at a 2:1 ratio, the smooth recline of the back with the limited front rise of the seat to keep feet on the floor and improve circulation to legs.



Dual-Action Tilt

Back reclines at a 2:1 ratio to seat angle creating relaxed positions while keeping feet relatively flat on the floor.



Posture Lock

Holds back in place in an infinite number of positions within a fixed range to offer variety in spinal alignment and weight distribution.

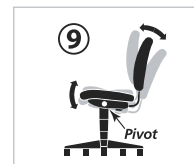

Multi-Task Control

Single lever easily adjusts seat and back angles independently, providing an infinite number of locking positions within a fixed range for customized comfort.



Asynchronous Control

Three levers modify: angle of back relative to seat; tilt (free float or locking); and forward tilt. Offers a wide variety of movement, spinal alignment and weight distribution.

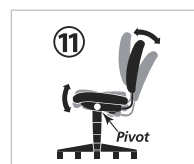

Dual-Clutch Posture Control

Seat and back angles adjust independently and lock in infinite positions within a fixed range – ideal for quick adaptation to different activities and multiple users.



Variable Synchro-Tilt

Back reclines in a 2:1 ratio to seat angle. Chair tilts freely, locks in five positions, or tilts forward to alleviate pressure points.

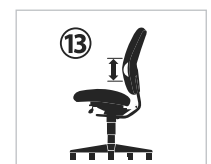

Integral Lumbar Support

Lumbar support within the chair back is height adjustable for proper placement; alleviates back stress.

ELUSION® TASK    

Multifunction mechanism with seat glide allows back angle adjustment relative to seat, adjustable tilt (free floating or infinite locking positions) and forward tilt. Cool, breathable mesh back. Contoured seat cushion with waterfall edge to help relieve pressure on legs. Height- and width-adjustable arms with soft polyurethane pads. Five-star base with casters for easy mobility.

Elusion Mesh Mid-Back Multifunction Chair

Seat Height: 17.7" to 21.4"
 Weight Capacity: Supports Up to 275 lb
 Color: Black
 Seat Surface Material: PU Leather
 Back Surface Material: Mesh
 Shipping Weight: 57.5 lb
ALEEL4215 \$574 EA

- 1
- 2
- 3
- 4
- 8
- 9
- 13



Elusion Mesh Mid-Back Multifunction Chair

Seat Height: 17.7" to 21.4"
 Weight Capacity: Supports Up to 275 lb
 Color: Black
 Seat Surface Material: Premium Fabric
 Back Surface Material: Mesh
 Shipping Weight: 56.2 lb
ALEEL42ME10B \$442 EA

- 1
- 2
- 3
- 4
- 8
- 9
- 13



Elusion Mesh High-Back Multifunction Chair

Seat Height: 17.2" to 20.6"
 Weight Capacity: Supports Up to 275 lb
 Color: Black
 Seat Surface Material: Premium Fabric
 Back Surface Material: Mesh
 Shipping Weight: 57.2 lb
ALEEL41ME10B \$538 EA

- 1
- 2
- 3
- 4
- 8
- 9
- 13



Seating

Task | Stool | Guest

ELUSION® TASK

- Clean, classic styling complements the busy office environment.
- Contoured seat cushion with waterfall edge to help relieve pressure on legs.
- Height- and width-adjustable arms with soft polyurethane pads.
- Five-star base with casters for easy mobility.
- Breathable mesh back for all day support.
- Height adjustable ratchet back for optimal lumbar support.



Elusion Mesh Stool

Overall Size: 22.6" to 31.6" Seat Height
Weight Capacity: Supports Up to 275 lb
Color: Black
Seat Surface Material: Fabric
Back Surface Material: Mesh
Shipping Weight: 53 lb

ALEEL4614 \$578 EA

1 2 13

Elusion Mesh Mid-Back Swivel/Tilt Chair

Seat Height: 17.9" to 21.6"
Weight Capacity: Supports Up to 275 lb
Color: Black
Seat Surface Material: Mesh
Back Surface Material: Mesh
Shipping Weight: 49.5 lb

ALEEL42B18 \$490 EA

1 2 4 12 13



Elusion Mesh Mid-Back Swivel/Tilt Chair

Seat Height: 17.9" to 21.8"
Weight Capacity: Supports Up to 275 lb
Color: Black
Seat Surface Material: Fabric
Back Surface Material: Mesh
Shipping Weight: 50.7 lb

ALEEL42BME10B \$395 EA

1 2 4 12 13



ELUSION® NESTING

- Ideal for training and conference rooms, or collaborative environments.
- Flip-up nesting seat design for easy high-density storage.
- Molded foam seat for resiliency and all day comfort.
- Cool breathable mesh back upholstery.
- Four-leg metal base with casters for durability and mobility.
- Includes 2 chairs per carton.



Elusion Mesh Nesting Chairs with Padded Arms

Seat Height: 18.1"
Weight Capacity: Supports Up to 275 lb
Color: Black
Seat Surface Material: Fabric
Back Surface Material: Mesh
Shipping Weight: 67.5 lb

ALEEL4914     \$609 CT



Elusion Mesh Nesting Chair

Seat Height: 18.1"
Weight Capacity: Supports Up to 275 lb
Color: Black
Seat Surface Material: Fabric
Back Surface Material: Mesh
Shipping Weight: 58 lb

ALEEL4915     \$609 CT



ELUSION™ STACKING

Coordinate across your office with Alera® Elusion™ Series chairs. Ideal for collaborative working environments; training, conference and waiting rooms. Breathable mesh back for cool comfort. Thickly cushioned, contoured seat for enhanced comfort and long-lasting support. Conveniently stack up to five high. Casters and glides are included.

Elusion Mesh Back Stacking Guest Chair

Seat Height: 18.4"
Weight Capacity: Supports Up to 275 lb
Color: Black
Seat Surface Material: Fabric
Back Surface Material: Mesh
Shipping Weight: 25.2 lb

ALEEL4314     \$305 EA



ETROS TASK



- An economical choice for mesh comfort.
- Breathable mesh back.
- Adjustable lumbar support.
- Five-star base with casters for easy mobility.



Etros High-Back Swivel/Tilt Chair

Seat Height: 18.1" to 22"
 Weight Capacity: Supports Up to 275 lb
 Color: Black
 Seat Surface Material: Mesh Fabric
 Back Surface Material: Mesh
 Shipping Weight: 41.8 lb

ALEET4117B \$437 EA

1 4 13



Etros Mesh Mid-Back Petite Multifunction Chair

Seat Height: 17.2" to 20.9"
 Weight Capacity: Supports Up to 275 lb
 Color: Black
 Seat Surface Material: Mesh Fabric
 Back Surface Material: Mesh
 Shipping Weight: 52 lb

ALEET4017 \$553 EA

1 2 3 4 9 13



Etros Mesh Mid-Back Swivel/Tilt Chair

Seat Height: 18" to 22"
 Weight Capacity: Supports Up to 275 lb
 Color: Black
 Seat Surface Material: Mesh Fabric
 Back Surface Material: Mesh
 Shipping Weight: 33.8 lb

ALEET42ME10B \$344 EA

1 4 13



Etros Mesh Mid-Back Petite Swivel/Tilt Chair

Seat Height: 17.7" to 21.7"
 Weight Capacity: Supports Up to 275 lb
 Color: Black
 Seat Surface Material: Mesh Fabric
 Back Surface Material: Mesh
 Shipping Weight: 35.8 lb

ALEET4017B \$355 EA

1 4 13



Etros All Mesh Mid-Back Chair

Seat Height: 15.7" to 19.7"
 Weight Capacity: Supports Up to 275 lb
 Color: Black
 Seat Surface Material: Mesh
 Back Surface Material: Mesh
 Shipping Weight: 44 lb

ALEET4218 \$493 EA

1 4 13



Etros Drafting Stool

Seat Height: 25.2" to 35.2"
 Weight Capacity: Supports Up to 275 lb
 Color: Black
 Seat Surface Material: Mesh Fabric
 Back Surface Material: Mesh
 Shipping Weight: 39.7 lb

ALEET4614 \$487 EA

1 13

Seating

WESSEX TASK



- Ideal for any workspace.
- Combines modern design with reliable performance.
- Fixed arms for added support; can be assembled with or without arms.

Wessex Mesh Back Chair

Seat Height: 17.2" to 20.9"
 Weight Capacity: Supports Up to 275 lb
 Color: Black
 Seat Surface Material: Fabric
 Back Surface Material: Mesh
 Shipping Weight: 28 lb

ALEWX42BME17 \$232 EA



Wessex Mesh Back Chair

Seat Height: 17.1" to 20.8"
 Weight Capacity: Supports Up to 275 lb
 Color: Gray/White
 Seat Surface Material: Fabric
 Back Surface Material: Mesh
 Shipping Weight: 28 lb

ALEWX42BME47 \$232 EA



Wessex Mesh Back Chair

Seat Height: 17.1" to 20.9"
 Weight Capacity: Supports Up to 275 lb
 Color: Seafoam/White
 Seat Surface Material: Fabric
 Back Surface Material: Mesh
 Shipping Weight: 28 lb

ALEWX42BME24 \$232 EA



Wessex Fabric Back Chair

Seat Height: 17.1" to 20.8"
 Weight Capacity: Supports Up to 275 lb
 Color: Black
 Seat Surface Material: Fabric
 Back Surface Material: Fabric
 Shipping Weight: 29.8 lb

ALEWX4217 \$232 EA



WESSEX DRAFTING STOOL



- Work comfortably with this adjustable-height drafting stool.
- Includes a foot ring for added comfort when seated.
- Can be assembled with or without arms.

Wessex Mesh Back Drafting Stool

Seat Height: 29" to 33.7"
 Weight Capacity: Supports Up to 275 lb
 Color: Black
 Seat Surface Material: Fabric
 Back Surface Material: Mesh
 Shipping Weight: 35.9 lb

ALEWX46BME17 \$263 EA



Wessex Upholstered Back Drafting Stool

Seat Height: 29" to 33.7"
 Weight Capacity: Supports Up to 275 lb
 Color: Black
 Seat Surface Material: Fabric
 Back Surface Material: Fabric
 Shipping Weight: 36.4 lb

ALEWX4614 \$314 EA



WESSEX GUEST

Ideal for any lobby or reception area. Breathable mesh back and soft fabric padded seat. Metal frame ensures strong support and stability. Equipped with casters and glides for smooth movement on hardwood or carpet.

Wessex Mesh Fabric Guest Chair

Seat Height: 18.7"
 Weight Capacity: Supports Up to 275 lb
 Color: Black
 Seat Surface Material: Fabric
 Back Surface Material: Mesh Back
 Shipping Weight: 19 lb

ALEWX43BME17 \$202 EA



MOTA BIG AND TALL

Generously padded, contoured seating that's ideal for the big and tall user. Reinforced seating structure and steel base for maximum reliable support. Enhanced padding and fabrics for extra support all day long. Welded integrated foot ring for leg support. T-arms for optimal arm positioning. Waterfall seat edge reduces pressure points at the back of the knees.

Mota Series Big and Tall Stool

Seat Height: 28.7" to 32.7"
 Weight Capacity: Supports Up to 450 lb
 Color: Black
 Seat Surface Material: Fabric
 Back Surface Material: Fabric
 Shipping Weight: 65 lb
ALEMT4610 **\$761 EA**



1

FASENY BIG AND TALL

All-day comfort with a thickly padded, fabric seat and breathable, mesh back. Fully customizable adjustments, specifically designed for the big and tall user. Width and height-adjustable armrests for back and shoulder support. Swivel-tilt lumbar support with locking, reclining tension control. Supports up to 400 lbs. Some assembly required.

Faseny Series Big and Tall Manager Chair

Seat Height: 17.5" to 21.7"
 Weight Capacity: Supports Up to 400 lb
 Color: Black
 Seat Surface Material: Fabric
 Back Surface Material: Mesh
 Shipping Weight: 69.1 lb
ALEFN44B14 **\$514 EA**



1 2 4 13

MAXXIS BIG AND TALL

This cushioned bonded leather chair provides maximum comfort and support for the big and tall users. Unique gel cooling pad technology under the upholstery provides constant even cooling. Coil spring technology in the seat enhances the sitting experience for a more mattress-like support. Heavy-duty chrome base and mechanism are reinforced and help to evenly distribute weight. Integral to the chair are ultra padded armrests, headrest, and bolsters. Waterfall seat edge helps to reduce pressure points at the back of the knee.

Maxxis Series Big/Tall Bonded Leather Chair

Seat Height: 19.7" to 25"
 Weight Capacity: Supports Up to 500 lb
 Color: Black/Chrome
 Seat Surface Material: Bonded Leather
 Back Surface Material: Bonded Leather
 Shipping Weight: 78.5 lb
ALEMS4419 **\$820 EA**



1 4 13

EGINO BIG AND TALL

Highback manager's chair for big and tall occupants. Smooth, cushioned, leather back and seat are easy-to-clean. Ergonomic chair with seat height and tilt adjustment.

Egino Big and Tall Chair

Seat Height: 19.8" to 23.7"
 Weight Capacity: Supports Up to 400 lb
 Color: Black
 Seat Surface Material: Bonded Leather
 Back Surface Material: Bonded Leather
 Shipping Weight: 54 lb
ALEEG44B19 **\$349 EA**



1 4

PLUS® XL SERIES



XL Series Big and Tall Mid-Back

Seat Height: 17.5" to 21"
 Weight Capacity: Supports Up to 500 lb
 Color: Black
 Seat Surface Material: Polyester
 Back Surface Material: Polyester
 Shipping Weight: 53 lb

ALECP210 **\$886 EA** 1 4



XL Series Big and Tall High-Back

Seat Height: 17.5" to 21"
 Weight Capacity: Supports Up to 500 lb
 Color: Black
 Seat Surface Material: Polyester
 Back Surface Material: Polyester
 Shipping Weight: 55 lb

ALECP110 **\$938 EA** 1 4

Seating

Mesh Back

MINERVA

- Arms move up and down to reduce neck strain and support the shoulders.
- Swivel-tilt mechanism with an upright tilt lock and tension knob for customized reclining resistance.
- Adjustable seat height, arm height, headrest (height and angle), lumbar support, tilt tension and tilt lock.
- Assembly required.



Seat Height: 17.2" to 21"
Weight Capacity: Supports Up to 275 lb
Seat Surface Material: Mesh
Back Surface Material: Mesh
Shipping Weight: 40.4 lb

ALEMV41BME18     **\$405 EA** Black Mesh

ALEMV41BME48     **\$405 EA** Gray Mesh

1 4 5 6 7 8 9 13

TAUNTON

Meticulously designed. Easily customize the arm height to fit your body for added comfort. Includes a synchro-tilt mechanism, upright tilt lock and tension knob for adjustable reclining resistance.



Ergonomic Mesh Swivel Task Chair

Seat Height: 17.4" to 21"
Weight Capacity: Supports Up to 275 lb
Color: Black
Seat Surface Material: Mesh
Back Surface Material: Mesh
Shipping Weight: 48.1 lb

ALETN41BME18     **\$415 EA**

1 4 5 6 7 8 11 12 13

AESON

Fully adjustable office chair fits into any office space. Padded, height-adjustable arms provide added support. Customize position with swivel-tilt with adjustable tension control.

Multifunction Task Chair

Seat Height: 15" to 18.8"
Weight Capacity: Supports Up to 275 lb
Color: Black
Seat Surface Material: Fabric
Back Surface Material: Mesh
Shipping Weight: 42.3 lb

ALEAS42M14     **\$231 EA**

1 4 5 6 7 8 9 11 12 13



HOLLINS

Mesh back and seat for breathability. Reliable performance. Adjustable arm height for a personalized fit. Swivel-tilt feature with adjustable tension control for added comfort. Includes adjustable seat and arm height, lumbar support, tilt tension and tilt lock.



Ergonomic Mesh Swivel Task Chair

Seat Height: 18.6" to 22.5"
Weight Capacity: Supports Up to 275 lb
Color: Black
Seat Surface Material: Mesh
Back Surface Material: Mesh
Shipping Weight: 43.7 lb

ALEHL42BME18     **\$395 EA**

1 4 8 12 13

KEMPTON

- Ideal for both office and home use.
- Features a fabric seat and breathable mesh back.
- Reliable performance.
- Adjustable lumbar to suit your back comfort needs.
- Arm height and width can be customized to support your forearms and maintain shoulder alignment.

Kempton Ergonomic Fabric Mesh Swivel Task Chair

Seat Height: 18.3" to 22.2"
 Weight Capacity: Supports Up to 275 lb
 Color: Black
 Seat Surface Material: Fabric
 Back Surface Material: Mesh
 Shipping Weight: 54 lb

ALEKP42BME17 \$415 EA



Kempton Fabric Mesh Task Stool

Seat Height: 26.6" to 33.6"
 Weight Capacity: Supports Up to 275 lb
 Color: Black
 Seat Surface Material: Fabric
 Back Surface Material: Mesh
 Shipping Weight: 56.2 lb

ALEKP46BME17 \$395 EA



ASHDALE

Boasting simple design and ergonomic benefits including synchro-tilt mechanism with tilt tension knob and variable position tilt lock, for the perfect fit. Adjustable lumbar support for maximum comfort.

Ashdale Ergonomic Fabric Swivel Task Chair

Seat Height: 18.2" to 21.9"
 Weight Capacity: Supports Up to 275 lb
 Color: Black
 Seat Surface Material: Mesh
 Back Surface Material: Mesh
 Shipping Weight: 31.3 lb

ALEAD41BME17     \$334 EA



ENVY

Mid-back chair features a crisp visual design and a variety of ergonomic adjustments at an irresistible price. Mesh back design offers breathable support and conforms to the natural curvature of the spine. Adjustable-height and width arms move up and down, as well as, toward and away from the body to adapt to various body sizes. Asynchronous control offers a wide range of movement, assists in spinal alignment and distributes users weight evenly. Tilt tension and lumbar support adapts to support the lower back and can be adjusted to satisfy a variety of different users. 360-degree swivel provides ease of movement in any direction.

Envy Series Mesh Mid-Back Multifunction Chair

Seat Height: 17" to 21.5"
 Weight Capacity: Supports Up to 250 lb
 Color: Black
 Seat Surface Material: Fabric
 Back Surface Material: Fabric
 Shipping Weight: 45 lb

ALENV42M14     \$920 EA



FASENY BIG AND TALL

All-day comfort with a thickly padded, fabric seat and breathable, mesh back. Fully customizable adjustments, specifically designed for the big and tall user. Width and height-adjustable armrests for back and shoulder support. Swivel-tilt lumbar support with locking, reclining tension control.

Faseny Series Big and Tall Manager Chair

Seat Height: 17.5" to 21.7"
 Weight Capacity: Supports Up to 400 lb
 Color: Black
 Seat Surface Material: Fabric
 Back Surface Material: Mesh
 Shipping Weight: 59.1 lb

ALEFN44B14     \$514 EA

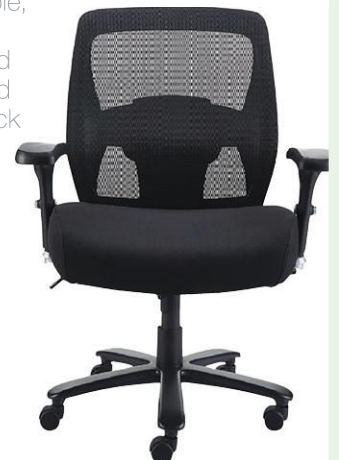

Seating

EB

Flip-back arms pivot back and out of the way when not needed. Breathable mesh back and generously padded seat and armrests for all day comfort.

EB-E Series Swivel/Tilt Mid-Back Mesh Chair

Seat Height: 18.1" to 22"
 Weight Capacity: Supports Up to 275 lb
 Color: Black
 Seat Surface Material: Fabric Mesh
 Back Surface Material: Mesh
 Shipping Weight: 34 lb

ALEEBE4217 **\$348 EA**

1 4 13



PLUS® XL BIG AND TALL



- High-capacity gas lift for hassle-free height adjustment.
- Heavy-duty construction provides strength and durability.
- Heavy-duty swivel seat control with optimized back angle provides stable support.
- Lavishly-sized sculptured seat and back offer maximum comfort.
- Contoured stitched upholstery and custom-designed back strap deliver superior aesthetics.



XL Series Big and Tall High-Back

Seat Height: 17.5" to 21"
 Weight Capacity: Supports Up to 500 lb
 Color: Black
 Seat Surface Material: Fabric
 Back Surface Material: Fabric
 Shipping Weight: 55 lb

ALECP110 **\$938 EA**

1 4

XL Series Big and Tall

Seat Height: 17.5" to 21"
 Weight Capacity: Supports Up to 500 lb
 Color: Black
 Seat Surface Material: Fabric
 Back Surface Material: Fabric
 Shipping Weight: 53 lb

ALECP210 **\$886 EA**

1 4



WRIGLEY 24/7

Designed with durability in mind and smart ergonomic features for comfort and performance. Multifunction mechanism allows back angle adjustment relative to seat, adjustable and forward tilt. Waterfall seat edge reduces pressure at the back of knees.

Multifunction Task Chair

Seat Height: 17.2" to 20.6"
 Weight Capacity: Supports Up to 300 lb
 Color: Black
 Seat Surface Material: Fabric
 Back Surface Material: Fabric
 Shipping Weight: 70.6 lb

ALEHPT4101 **\$763 EA**

1 2 3 4 9



ESSENTIA

Contoured seat and back provide comfort for long hours of sitting. Features back depth adjustment and rotates a full 360° in either direction for ease of motion. Black five-star base with casters. Durable 100% acrylic upholstery.

Essentia Series Swivel Task Chair

Seat Height: 17.7" to 22.4"
 Weight Capacity: Supports Up to 275 lb
 Color: Black
 Seat Surface Material: Acrylic
 Back Surface Material: Acrylic
 Shipping Weight: 27.1 lb

ALEVT48FA10B **\$230 EA**

1



KËSSON

So comfortable, you might forget you're at work! Designed for long-lasting, mattress-like comfort. Molded foam in back and seat for resiliency and maximum comfort.

Kesson Series High-Back Office Chair

Seat Height: 19.2" to 22.7"
 Weight Capacity: Supports Up to 300 lb
 Color: Black
 Seat Surface Material: Fabric
 Back Surface Material: Fabric
 Shipping Weight: 51.8 lb

ALEKS4110 **\$573 EA**

1 4



Bonded Leather BIRNS

High-Back Task Chair

Seat Height: 18.1" to 22.1"
Weight Capacity: Supports Up to 250 lb
Color: Black/Chrome
Seat Surface Material: Bonded Leather
Back Surface Material: Bonded Leather
Shipping Weight: 44.1 lb

ALEBN41B19 **\$292 EA**

1 4 13



VEON

- All day mattress-like comfort.
- Coil spring cushioned seat provides long-lasting, mattress-like comfort.
- Ergonomic side bolsters for added support.
- Adjustable lumbar support for optimal back positioning.
- Integrated cushioned leather headrest and padded leather armrests.



FULFORD

Bonded Leather High-Back Manager's Chair

Seat Height: 18.6" to 22.6"
Weight Capacity: Supports Up to 275 lb
Color: Black
Seat Surface Material: Bonded Leather
Back Surface Material: Bonded Leather
Shipping Weight: 48.1 lb

ALEFD41B19 **\$354 EA**

1 4 13



High-Back Chair

Seat Height: 19.7" to 22.4"
Weight Capacity: Supports Up to 275 lb
Color: Black/Graphite
Seat Surface Material: Bonded Leather
Back Surface Material: Bonded Leather
Shipping Weight: 49.2 lb

ALEVN4119 **\$519 EA**

1 4 13



KIRKDALE

Bonded Leather Manager Chair

Seat Height: 16.2" to 22.8"
Weight Capacity: Supports Up to 275 lb
Color: Black
Seat Surface Material: Bonded Leather
Back Surface Material: Bonded Leather
Shipping Weight: 48.5 lb

ALEKD4519 **\$405 EA**

1 4



High-Back Chair

Seat Height: 19.7" to 22.4"
Weight Capacity: Supports Up to 275 lb
Color: Brown/Bronze
Seat Surface Material: Bonded Leather
Back Surface Material: Bonded Leather
Shipping Weight: 49.2 lb

ALEVN4159 **\$519 EA**

1 4 13

Genuine Leather STRADA

Tailored seat and back with top-grain leather upholstery. Waterfall seat reduces pressure at the back of knees. Roll armrests with padded leather caps for added comfort.

Strada Series High-Back Swivel/Tilt Top-Grain Leather Chair

Seat Height: 17.9" to 21.9"
Weight Capacity: Supports Up to 275 lb
Color: Black
Seat Surface Material: Top-Grain Leather
Back Surface Material: Top-Grain Leather
Shipping Weight: 50.2 lb

ALESR41LS10B **\$655 EA**

1 4



LEITHEN

- Smooth, bonded leather and quilted fabric task chair.
- Ergonomic chair with seat height and tilt adjustment.
- Built-in reclining mechanism for position adjustment.
- Flip-up, height-adjustable, padded arms for comfort and support.
- Supports up to 275 lbs.

Midback Chair

Seat Height: 16.8" to 20.5"
Weight Capacity: Supports Up to 275 lb
Color: Black/Silver
Seat Surface Material: Bonded Leather
Back Surface Material: Bonded Leather
Shipping Weight: 44.1 lb

ALELT4249 **\$286 EA**

1 4 8 13

Midback Chair

Seat Height: 16.8" to 20.5"
Weight Capacity: Supports Up to 275 lb
Color: Gray/Silver
Seat Surface Material: Bonded Leather
Back Surface Material: Bonded Leather
Shipping Weight: 44.1 lb

ALELT4219 **\$286 EA**

1 4 8 13



Seating

Bonded & PU Leather

EGINO

Big and Tall Chair

Seat Height: 19.7" to 23.7"
 Weight Capacity: Supports Up to 400 lb
 Color: Black
 Seat Surface Material: Bonded Leather
 Back Surface Material: Bonded Leather
 Shipping Weight: 54 lb

ALEEG44B19 **\$349** EA

1 4



MAXXIS

Big and Tall

Seat Height: 19.7" to 25"
 Weight Capacity: Supports Up to 500 lb
 Color: Black/Chrome
 Seat Surface Material: Bonded Leather
 Back Surface Material: Bonded Leather
 Shipping Weight: 78.5 lb

ALEMS4419 **\$820** EA

1 4 13



BROSNA OFFICE CHAIRS



- Durable, easy-to-clean, faux leather upholstery.
- Lumbar support cradles the back with gentle support.
- Swivel-tilt allows for customized angle adjustment.
- Pneumatic seat height adjustment.
- Fixed, padded armrests enhance comfort.



Brosna Series Mid-Back Task Chair

Seat Height: 18.2" to 21.8"
 Weight Capacity: Supports Up to 250 lb
 Seat Surface Material: PU Leather
 Back Surface Material: PU Leather
 Shipping Weight: 43.9 lb

ALEBRN42B19 **\$227** EA Black
ALEBRN42B59 **\$227** EA Brown/Black

1 4

DALIBOR

Manager Chair

Seat Height: 17.5" to 21.3"
 Weight Capacity: Supports Up to 250 lb
 Color: Black
 Seat Surface Material: PU Leather
 Back Surface Material: PU Leather
 Shipping Weight: 37.9 lb

ALEDB41B19 **\$218** EA

1 4 13



DARNICK

Manager Chair

Seat Height: 17.1" to 20.1"
 Weight Capacity: Supports Up to 275 lb
 Color: Brown
 Seat Surface Material: Bonded Leather
 Back Surface Material: Bonded Leather
 Shipping Weight: 45.3 lb

ALEDN42B19 **\$344** EA

1 4 8 13



EDDLESTON

Leather Manager Chair

Seat Height: 16.9" to 21.1"
 Weight Capacity: Supports Up to 275 lb
 Color: Black/Chrome
 Seat Surface Material: Bonded Leather
 Back Surface Material: Bonded Leather
 Shipping Weight: 34.4 lb

ALEED41B19 **\$311** EA

1 4



FRAZE

Executive High-Back Swivel/Tilt Bonded Leather Chair

Seat Height: 17.7" to 21.7"
 Weight Capacity: Supports Up to 275 lb
 Color: Black
 Seat Surface Material: Bonded Leather
 Back Surface Material: Bonded Leather
 Shipping Weight: 45.2 lb

ALEFZ41LS10B **\$367** EA

1 4



PU Leather

BREICH

Manager Chair

Seat Height: 16.7" to 20.4"
 Weight Capacity: Supports Up to 275 lb
 Color: Black
 Seat Surface Material: PU Leather
 Back Surface Material: PU Leather
 Shipping Weight: 28.4 lb

ALEBC42B19 \$210 EA

1 4



OXNAM

High-Back Task Chair

Seat Height: 17.6" to 21.4"
 Weight Capacity: Supports Up to 275 lb
 Color: Black
 Seat Surface Material: PU Leather
 Back Surface Material: PU Leather
 Shipping Weight: 37.5 lb

ALEON41B19 \$293 EA

1 4



High-Back Task Chair

Seat Height: 17.6" to 21.4"
 Weight Capacity: Supports Up to 275 lb
 Color: Gray/Black
 Seat Surface Material: PU Leather
 Back Surface Material: PU Leather
 Shipping Weight: 38.2 lb

ALEON41B49 \$293 EA

1 4



HARTHOPE

Leather Task Chair

Seat Height: 17.6" to 21.3"
 Weight Capacity: Supports Up to 275 lb
 Color: Black
 Seat Surface Material: PU Leather
 Back Surface Material: PU Leather
 Shipping Weight: 34.4 lb

ALEHH42B19 \$210 EA

1 4 5 6 7 8



Faux Leather



- Contemporary cushioned seating with a slim profile.
- Chrome accents.
- Waterfall seat reduces pressure on the back of the knees for improved circulation.
- Padded arm caps for comfort and support.



NERATOLI

High-Back Slim Profile Chair

Seat Height: 17.3" to 21.3"
 Weight Capacity: Supports Up to 275 lb
 Seat Surface Material: Stain-Resistant Faux Leather
 Back Surface Material: Stain-Resistant Faux Leather

		Shipping Weight	
ALENR4119	\$666 EA	48.8 lb	
ALENR4139	\$666 EA	44.6 lb	

1 4



Color
 Black/Chrome
 Red/Chrome

Mid-Back Slim Profile Chair

Seat Height: 18.3" to 21.9"
 Weight Capacity: Supports Up to 275 lb
 Color: White/Chrome
 Seat Surface Material: Stain-Resistant Faux Leather
 Back Surface Material: Stain-Resistant Faux Leather
 Shipping Weight: 45.4 lb

ALENR4206 \$613 EA

1 4



Mid-Back Slim Profile Chair

Seat Height: 18.3" to 21.9"
 Weight Capacity: Supports Up to 275 lb
 Color: Black/Chrome
 Seat Surface Material: Stain-Resistant Faux Leather
 Back Surface Material: Stain-Resistant Faux Leather
 Shipping Weight: 47.3 lb

ALENR4219 \$613 EA

1 4



GAMING CHAIR



- Race car style gaming chair.
- 90 to 130° reclining back.
- Adjustable lumbar and headrest pillows.
- Height adjustable arms.



Racing Style Ergonomic Gaming Chair

Seat Height: 15.9" to 19.8"
 Weight Capacity: Supports Up to 275 lb
 Seat Surface Material: PU Leather
 Back Surface Material: PU Leather
 Shipping Weight: 48.5 lb

ALEGM4136	\$356 EA	Black/Red Trim/Red
ALEGM4146	\$356 EA	Black/Gray Trim/Gray

1 4 8

Seating

LAB STOOL

This classic "lab" stool is easy to keep clean and scoot around a busy workplace. Thick padded, molded-foam seat retains its comfort and shape, even through a prolonged use. Chrome five-star base for maximum durability. Easy to store underneath nearly any work surface.

Height Adjustable Lab Stool

Seat Height: 19.7" to 24.8"
 Weight Capacity: Supports Up to 275 lb
 Color: Black/Chrome
 Seat Surface Material: Polyurethane
 Shipping Weight: 15.6 lb

ALEUS4716 \$161 EA

1



MOTA BIG AND TALL STOOL

Generously padded, contoured seating that's ideal for the big and tall user. Reinforced seating structure and steel base for maximum reliable support. Enhanced padding and fabrics for extra support all day long.

Mota Series Big and Tall Stool

Seat Height: 28.7" to 32.7"
 Weight Capacity: Supports Up to 450 lb
 Color: Black
 Seat Surface Material: Fabric
 Back Surface Material: Fabric
 Shipping Weight: 65 lb

ALEMT4610 \$761 EA

1



PLUS™ IL STOOL

Tools-free seat height adjustment in a 10" range for use in a variety of applications. Foldable for compact storage. Vinyl upholstered seat and back wipes clean for easy maintenance. Welded tubular steel frame with a powder coat finish ensures strength and durability.

IL Series Height-Adjustable Folding Stool

Seat Height: 17.5" to 27.5"
 Weight Capacity: Supports Up to 300 lb
 Color: Black
 Seat Surface Material: Fabric-Backed Vinyl
 Back Surface Material: Fabric-Backed Vinyl
 Shipping Weight: 20 lb

ALECS612 \$329 EA



INDUSTRIAL STOOLS

- Ideal in the shop, garage, science or art lab, factory floor, or anywhere where durability matters most.
- Sturdy steel frame features a powder coat finish to resist scratching.
- Warp-, crack-, and chip-proof Masonite board is riveted to the seat pan.
- Built-in foot ring provides a place to rest your feet when seated.
- Includes non-marring floor glides.

CASTERS

- Strength and high performance.
- These replacement casters are an excellent choice for most Alera® seating.
- Weight rated 100 lb. per caster wheel.

Dual Wheel Hooded Caster

Application: Carpeted Floors
 Overall Size: 1.5" Hard Nylon Wheel
 Color: Matte Black
 Material: Nylon
 Shipping Weight: 1.2 lb

ALECASTERHT1 \$25 ST



Dual Wheel Hooded Caster

Application: Hard Floors
 Overall Size: 2" Soft Nylon Wheel
 Color: Black
 Material: Nylon
 Shipping Weight: 1.2 lb

ALECASTERST2 \$28 ST



Industrial Metal Shop Stool

Seat Height: 24"
 Weight Capacity: Supports Up to 300 lb
 Color: Brown/Gray
 Seat Surface Material: Masonite
 Shipping Weight: 11.4 lb

ALEIS6624G \$78 EA



Industrial Metal Shop Stool

Seat Height: 30"
 Weight Capacity: Supports Up to 300 lb
 Color: Brown/Gray
 Seat Surface Material: Masonite
 Shipping Weight: 12.9 lb

ALEIS6630G \$79 EA



INTERVAL



- Compact and comfortable—Ideal for all-day seating in tight spaces.
- Molded plastic, impact-resistant shell.
- Waterfall seat edge helps relieve pressure points on the underside of legs.
- Back height adjustment for optimal lumbar support.
- Durable upholstery designed to resist abrasions and fading.
- Optional Arms sold separately.



Interval Swivel/Tilt Task Chair

Seat Height: 18.1" to 23.2"
 Weight Capacity: Supports Up to 275 lb
 Color: Black
 Seat Surface Material: Bonded Leather
 Back Surface Material: Bonded Leather
 Shipping Weight: 30.2 lb

ALEIN4819 \$296 EA

1 4



Interval Swivel/Tilt Task Chair

Seat Height: 18.4" to 23.5"
 Weight Capacity: Supports Up to 275 lb
 Color: Black
 Seat Surface Material: 100% Acrylic
 Back Surface Material: 100% Acrylic
 Shipping Weight: 30.2 lb

ALEIN4811 \$293 EA

1 4



Interval Swivel Task Stool

Seat Height: 23.9" to 34.5"
 Weight Capacity: Supports Up to 275 lb
 Color: Black
 Seat Surface Material: 100% Acrylic
 Back Surface Material: 100% Acrylic
 Shipping Weight: 35.3 lb

ALEIN4611 \$371 EA

1



Interval Swivel Task Stool

Seat Height: 23.9" to 34.5"
 Weight Capacity: Supports Up to 275 lb
 Color: Black
 Seat Surface Material: PVC-Free Faux Leather
 Back Surface Material: PVC-Free Faux Leather
 Shipping Weight: 35.3 lb

ALEIN4616 \$371 EA

1



Interval Swivel Task Stool

Seat Height: 23.9" to 34.5"
 Weight Capacity: Supports Up to 275 lb
 Color: Graphite Gray/Black
 Seat Surface Material: 100% Acrylic
 Back Surface Material: 100% Acrylic
 Shipping Weight: 35.3 lb

ALEIN4641 \$371 EA

1



Optional Height-Adjustable T-Arms for Essentia and Interval Chairs

Color: Black
 Material: Padded Metal & Polyurethane
 Armrest Material: Padded Metal & Polyurethane
 Shipping Weight: 7.4 lb

ALEIN49AKA10B \$81 FR



Optional Fixed Height T-Arms for Essentia and Interval Chairs

Color: Black
 Material: Padded Metal & Polyurethane
 Armrest Material: Padded Metal & Polyurethane
 Shipping Weight: 6.6 lb

ALEIN49AKB10B \$76 FR

Seating

Folding | Stacking | Accessory

ARMLESS STEEL FOLDING CHAIR



- Create additional seating in any indoor or outdoor space.
- Durable, metal base is designed to withstand heavy use.
- Covered feet prevent floor scratches and scuffs.
- Armless design is mobile and versatile for all occasions.
- Easy-to-clean surface.
- Comes 4 per carton

Armless Steel Folding Chair

Seat Height: 17"
Weight Capacity: Supports Up to 275 lb
Seat Surface Material: Steel
Back Surface Material: Steel
Shipping Weight: 40.1 lb

ALECA941 \$171 ct Black
ALECA944 \$171 ct Taupe



PU PADDED FOLDING CHAIR

Create additional seating in any indoor or outdoor space. Cushioned, black faux leather back and seat wipes clean. Durable, metal base is designed to withstand heavy use. Covered feet prevent floor scratches and scuffs. Armless design is mobile and versatile for all occasions. Each pack includes four, easy-to-clean chairs. Supports up to 250 lbs. Comes 4 per carton.

PU Padded Folding Chair

Seat Height: 17"
Weight Capacity: Supports Up to 250 lb
Color: Black
Seat Surface Material: PU Leather
Back Surface Material: PU Leather
Shipping Weight: 45.2 lb

ALECA9416 \$253 ct



Stacking

RESIN STACKING CHAIR

Expands seating in any space with sleek design. More comfortable than traditional folding chairs. Contoured seats and backs support the body. Durable plastic resin base and back with steel frame. Integrated handle for mobility and quick set-up. Stacking design minimizes storage space. Comes 4 per carton.

Resin Stacking Chair

Seat Height: 18.5"
Weight Capacity: Supports Up to 275 lb
Color: Black
Seat Surface Material: Resin
Back Surface Material: Resin
Shipping Weight: 58.7 lb

ALECA671 \$451 ct



MOLDED RESIN FOLDING CHAIR

Classic chair for all occasions. Great for indoor and outdoor use. Contoured seat and back for maximum comfort. Powder coated steel frame resists corrosion and provides exceptional strength. Folds flat for compact storage. Nonmarring foot caps protect surfaces. Comes 4 per carton.

Molded Resin Folding Chair

Seat Height: 18.2"
Weight Capacity: Supports Up to 225 lb
Color: White/Dark Gray
Seat Surface Material: Resin
Back Surface Material: Resin
Shipping Weight: 31 lb

ALEFR9402 \$238 ct



Accessories

STACKING CHAIR DOLLY

Conveniently transport stacking chairs. Accommodates up to 12 chairs. Durable steel construction. Four 2" casters for mobility. Shipped assembled.

Stacking Chair Dolly

Weight Capacity: 320 lb
Color: Black
Material: Steel
Shipping Weight: 13.4 lb

ALESCCART \$91 EA



GENARO

- Clean, classic lines complement any office environment.
- Configure to create reception, lounge, conference, and waiting rooms.
- Thickly padded for maximum comfort.
- Durable upholstery withstands everyday use.
- Padded armrests for soft support.
- Sturdy steel sled base.

Genaro Fabric Half-Back Sled Base Guest Chair

Seat Height: 17.7"
 Weight Capacity: Supports Up to 275 lb
 Color: Black
 Seat Surface Material: 100% Polyester
 Back Surface Material: 100% Polyester
 Shipping Weight: 29.8 lb

ALERL43C11     \$264 EA



Genaro Faux Leather Half-Back Sled Base Guest Chair

Seat Height: 17.7"
 Weight Capacity: Supports Up to 275 lb
 Color: Black
 Seat Surface Material: Faux Leather
 Back Surface Material: Vinyl
 Shipping Weight: 29.8 lb

ALERL43C16     \$264 EA



HILDRED

Stylish guest chair provides comfort, support, and functionality. Durable, black, bonded leather back and seat. Additional comfort and support with fixed arms. Supports up to 275 lbs.

Hildred Guest Chair

Seat Height: 18.9"
 Weight Capacity: Supports Up to 275 lb
 Color: Black/Chrome
 Seat Surface Material: Bonded Leather
 Back Surface Material: Bonded Leather
 Shipping Weight: 35.3 lb

ALEHD4319     \$301 EA



ISPARA

Contemporary geometric styling in soft durable bonded leather. Modular armless design allows multiple chairs to be configured to create layouts that work in any room. Heavy duty silver steel structure withstands constant use and movement.

Ispara Armless Chair

Seat Height: 17.3"
 Weight Capacity: Supports Up to 400 lb
 Color: Black/Silver
 Seat Surface Material: Bonded Leather
 Back Surface Material: Bonded Leather
 Shipping Weight: 50.7 lb

ALERL8319CS     \$456 EA



MADARIS

A statement guest chair that feels as good as it looks. Soft touch, black bonded leather upholstery is easy-to-clean. Padded armrests for comfort. Stylish and durable solid wood frame. Ideal for lobbies, waiting room, or additional office seating.

Madaris Bonded Leather Guest Chair with Wood Trim Leg

Seat Height: 18.5"
 Weight Capacity: Supports Up to 275 lb
 Color: Black/Mahogany
 Seat Surface Material: Bonded Leather
 Back Surface Material: Bonded Leather
 Shipping Weight: 31.5 lb

ALEMA43ALS10M     \$470 EA



Seating

CAPTAIN CHAIR

A modern captain's chair with a commanding style. Make a statement at your desk, in the conference room, or the waiting room. Cushioned seat and back with durable fabric upholstery. Contoured rounded back and arms for the perfect support. Extended seat edge to help reduce pressure points at the back of the knee. Durable metal post legs.

Captain Guest Chair

Seat Height: 17.8"
 Weight Capacity: Supports Up to 275 lb
 Color: Gray Tweed/Chrome
 Seat Surface Material: Fabric
 Back Surface Material: Fabric
 Shipping Weight: 24.9 lb

ALECS4351 \$285 EA



SISKIN

Streamlined design. Sleek and modern. Perfect fit for any office setting. Reliable performance.

Siskin Fabric Managers Chair

Seat Height: 16.9" to 20.7"
 Weight Capacity: Supports Up to 275 lb
 Color: Gray/Chrome
 Seat Surface Material: Fabric
 Back Surface Material: Fabric
 Shipping Weight: 37.7 lb

ALESK4244 \$314 EA

1 4



ELGAR

Guest chair combines comfort, support and functionality. Breathable mesh back and cushioned fabric seat. Reliable performance. Fixed arms provide added comfort. Allows for fixed stability with glides (included). Assembly required.

Elgar Fabric Guest Chair

Seat Height: 17.8"
 Weight Capacity: Supports Up to 275 lb
 Color: Black
 Seat Surface Material: Fabric
 Back Surface Material: Mesh
 Shipping Weight: 20.3 lb

ALEER4317 \$222 EA



Metal Desking & Storage

Find a place for everything to create order out of chaos



Optimize your workspace with our Metal Desking and Storage collection, where durability meets function. Designed to provide long-lasting performance, our metal desks and storage solutions offer a sleek, modern aesthetic while keeping your office organized and efficient. Whether you're looking for multipurpose desks that adapt to your needs or sturdy filing cabinets to manage important documents, our products are built to help streamline your workflow. With a variety of configurations and sizes, our metal desks and storage units can be customized to fit your space and storage requirements, ensuring easy access to everything you need.

- Lateral Files 63-68
- Vertical Files 69-72
- Mobile Peds 73-75
- Storage Cabinets 76-78
- Bookcases 79
- Wire Shelving 80-85
- File Carts & Garment Racks 86-87
- Metal Desking 88-89

Metal Desking & Storage





LATERAL FILE CABINETS

- Drawers with side-to-side hang rails to accommodate letter/legal hanging files.
- Full drawer extension on steel ball bearing telescoping slide suspension.
- Stylish full-width radius edge recessed pulls.
- Anti-tipping interlock system allows only one drawer to open at a time.
- Single key core removable lock with two keys.

File Cabinet

2 Drawer 30" Wide

Overall Size: 30"W x 18.6"D x 28"H
Material: Steel
Shipping Weight: 101 lb

ALEHLF3029BL 	\$895 <small>EA</small>	Black
ALEHLF3029LG 	\$895 <small>EA</small>	Light Gray
ALEHLF3029PY 	\$895 <small>EA</small>	Putty
ALE23696  	\$960 <small>EA</small>	White



3 Drawer 30" Wide

Overall Size: 30"W x 18.6"D x 40.3"H
Weight Capacity: 80 lb
Material: Steel
Shipping Weight: 133 lb

ALEHLF3041BL 	\$1207 <small>EA</small>	Black
ALEHLF3041LG 	\$1207 <small>EA</small>	Light Gray
ALEHLF3041PY 	\$1207 <small>EA</small>	Putty
ALE23697  	\$1127 <small>EA</small>	White



4 Drawer 30" Wide

Overall Size: 30"W x 18.6"D x 52.5"H
Material: Steel
Shipping Weight: 148 lb

ALEHLF3054BL 	\$1347 <small>EA</small>	Black
ALEHLF3054LG 	\$1347 <small>EA</small>	Light Gray
ALEHLF3054PY 	\$1347 <small>EA</small>	Putty
ALE23698  	\$1300 <small>EA</small>	White



5 Drawer 30" Wide

Overall Size: 30"W x 18.6"D x 67.6"H
Weight Capacity: 80 lb
Material: Steel
Shipping Weight: 179 lb

ALEHLF3067BL 	\$1919 <small>EA</small>	Black
ALEHLF3067LG 	\$1919 <small>EA</small>	Light Gray
ALEHLF3067PY 	\$1919 <small>EA</small>	Putty
ALE23699  	\$2107 <small>EA</small>	White

 Extended Leadtime  Freight

LATERAL SERIES

- Drawers with side-to-side hang rails to accommodate letter/legal hanging files.
- Full drawer extension on steel ball bearing telescoping slide suspension.
- Stylish full-width radius edge recessed pulls.
- Anti-tipping interlock system allows only one drawer to open at a time.
- Single key core removable lock with two keys.
- Four adjustable leveling glides.
- Durable powder coated finish helps prevent scratches.



2 Drawer 36" Wide

Overall Size: 36"W x 18.6"D x 28"H
 Material: Steel
 Shipping Weight: 124 lb

ALEHLF3629BL	\$1014 EA	Black
ALEHLF3629CC	\$1014 EA	Charcoal
ALEHLF3629LG	\$1014 EA	Light Gray
ALEHLF3629PY	\$1014 EA	Putty

ALE23700	\$1055 EA	White
ALE23744	\$1055 EA	Silver
ALE24249	\$1055 EA	Red
ALE24250	\$1055 EA	Green
ALE24251	\$1055 EA	Blue



3 Drawer 36" Wide

Overall Size: 36"W x 18.6"D x 40.3"H
 Material: Steel
 Shipping Weight: 154 lb

ALEHLF3641BL	\$1303 EA	Black
ALEHLF3641CC	\$1303 EA	Charcoal
ALEHLF3641LG	\$1303 EA	Light Gray
ALEHLF3641PY	\$1303 EA	Putty

ALE23701	\$1303 EA	White
ALE23745	\$1303 EA	Silver
ALE24252	\$1303 EA	Red
ALE24253	\$1303 EA	Green
ALE24254	\$1303 EA	Blue

Metal Desking & Storage

LATERAL SERIES

- Drawers with side-to-side hang rails to accommodate letter/legal hanging files.
- Full drawer extension on steel ball bearing telescoping slide suspension.
- Stylish full-width radius edge recessed pulls.
- Anti-tipping interlock system allows only one drawer to open at a time.
- Single key core removable lock with two keys.
- Four adjustable leveling glides.
- Durable powder coated finish helps prevent scratches.



4 Drawer 36" Wide

Overall Size: 36"W x 18.6"D x 52.5"H
Material: Steel
Shipping Weight: 175 lb

ALEHLF3654BL	\$1596 EA	Black
ALEHLF3654CC	\$1596 EA	Charcoal
ALEHLF3654LG	\$1596 EA	Light Gray
ALEHLF3654PY	\$1596 EA	Putty

ALE23702	\$1596 EA	White
ALE23746	\$1596 EA	Silver
ALE24255	\$1596 EA	Red
ALE24256	\$1596 EA	Green
ALE24257	\$1596 EA	Blue



5 Drawer 36" Wide

Overall Size: 36"W x 18.6"D x 67.6"H
Material: Steel
Shipping Weight: 202 lb

ALEHLF3667BL	\$2216 EA	Black
ALEHLF3667CC	\$2216 EA	Charcoal
ALEHLF3667LG	\$2216 EA	Light Gray
ALEHLF3667PY	\$2216 EA	Putty

ALE23703	\$2216 EA	White
ALE23747	\$2216 EA	Silver
ALE24258	\$2216 EA	Red
ALE24259	\$2216 EA	Green
ALE24260	\$2216 EA	Blue

Extended Leadtime Freight

LATERAL SERIES

- Drawers with side-to-side hang rails to accommodate letter/legal hanging files.
- Full drawer extension on steel ball bearing telescoping slide suspension.
- Stylish full-width radius edge recessed pulls.
- Anti-tipping interlock system allows only one drawer to open at a time.
- Single key core removable lock with two keys.
- Four adjustable leveling glides.
- Durable powder coated finish helps prevent scratches.



2 Drawer 42" Wide

Overall Size: 42"W x 18.6"D x 28"H
 Material: Steel
 Shipping Weight: 145 lb

ALEHLF4229BL	\$1055 EA	Black		
ALEHLF4229CC	\$1055 EA	Charcoal		
ALEHLF4229LG	\$1055 EA	Light Gray		
ALEHLF4229PY	\$1055 EA	Putty		
			ALE23704	\$1130 EA
			ALE23748	\$1130 EA
				White
				Silver



3 Drawer 42" Wide

Overall Size: 42"W x 18.6"D x 40.3"H
 Material: Steel
 Shipping Weight: 174 lb

ALEHLF4241BL	\$1398 EA	Black		
ALEHLF4241CC	\$1398 EA	Charcoal		
ALEHLF4241LG	\$1398 EA	Light Gray		
ALEHLF4241PY	\$1398 EA	Putty		
			ALE16070	\$1398 EA
			ALE23705	\$1398 EA
			ALE23749	\$1398 EA
				Charcoal
				White
				Silver

Metal Desking & Storage

LATERAL SERIES

- Drawers with side-to-side hang rails to accommodate letter/legal hanging files.
- Full drawer extension on steel ball bearing telescoping slide suspension.
- Stylish full-width radius edge recessed pulls.
- Anti-tipping interlock system allows only one drawer to open at a time.
- Single key core removable lock with two keys.
- Four adjustable leveling glides.
- Durable powder coated finish helps prevent scratches.



4 Drawer 42" Wide

Overall Size: 42"W x 18.6"D x 52.5"H
Material: Steel
Shipping Weight: 196 lb

ALEHLF4254BL

\$1682 EA Black

ALEHLF4254CC

\$1682 EA Charcoal

ALEHLF4254LG

\$1682 EA Light Gray

ALEHLF4254PY

\$1682 EA Putty

ALE16071

\$1682 EA Charcoal

ALE23706

\$1682 EA White

ALE23750

\$1682 EA Silver

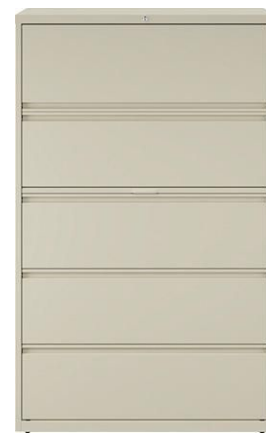

5 Drawer 42" Wide

Overall Size: 42"W x 18.6"D x 67.6"H
Material: Steel
Shipping Weight: 230 lb

ALEHLF4267BL

\$2271 EA Black

ALEHLF4267CC

\$2271 EA Charcoal

ALEHLF4267LG

\$2271 EA Light Gray

ALEHLF4267PY

\$2271 EA Putty

ALE16072

\$2271 EA Charcoal

ALE23707

\$2271 EA White

ALE23751

\$2271 EA Silver

LATERAL FILES

Lateral File with Roll-Out Shelves

Overall Size: 36"W x 18.6"D x 68.8"H
 Material: Steel
 Shipping Weight: 203 lb

- | | | |
|---|------------------|-------|
| ALE17901   | \$2271 EA | Putty |
| ALE17902   | \$2271 EA | Black |



Lateral File/Bookcase Combo

Overall Size: 36"W x 18.6"D x 60"H
 Color: Black
 Material: Steel
 Shipping Weight: 150 lb

- ALE16778**   **\$1308** EA



ACCESSORIES

Creates two rows of letter or legal size filing in one drawer/shelf of 36" files, or two drawers of 30" files.

Two Row Hangrails for 30" and 36" Wide Lateral File

Overall Size: 2.8"W x 19.5"D x 2.8"H
 Color: Aluminum
 Material: Aluminum
 Shipping Weight: 2.5 lb
 4 per pack

- ALEHLF3036**  **\$47** PK



Metal Desking & Storage

VERTICAL FILES

- The preferred method of storage when floor space is limited.
- Wire follower block keeps files upright.
- High-sided drawers equipped with hang rails for hanging folders.
- Strong aluminum handle and thumb latch.
- Drawers extend fully for easy access.
- Core removable lock allows files to be keyed alike.

2 Drawer Letter 22" Depth

Overall Size: 15"W x 22"D x 28.4"H
 Weight Capacity: 44.7 lb
 Material: Steel
 Shipping Weight: 40 lb

ALEHVF152229BL	\$398 EA	Black
ALEHVF152229LG	\$398 EA	Light Gray
ALEHVF152229PY	\$398 EA	Putty



3 Drawer Letter 22" Depth

Overall Size: 15"W x 22"D x 40.2"H
 Weight Capacity: 44.7 lb
 Material: Steel
 Shipping Weight: 54 lb

ALEHVF1541BL	\$648 EA	Black
ALEHVF1541LG	\$648 EA	Light Gray
ALEHVF1541PY	\$648 EA	Putty



4 Drawer Letter 22" Depth

Overall Size: 15"W x 22"D x 52"H
 Weight Capacity: 44.7 lb
 Material: Steel
 Shipping Weight: 68 lb

ALEHVF152252BL	\$650 EA	Black
ALEHVF152252LG	\$650 EA	Light Gray
ALEHVF152252PY	\$650 EA	Putty



VERTICAL FILES

- High-sided drawers for hanging folders.
- Wire follower-block keeps files upright.
- Drawers extend fully for easy access to material.
- Sturdy aluminum handle and thumb latch.
- Core removable lock allows files to be keyed-alike.

2 Drawer Legal 25" Depth

Overall Size: 18"W x 25"D x 28.4"H
 Material: Steel
 Shipping Weight: 47 lb

ALEHVF1929BL	\$529 EA	Black
ALEHVF1929LG	\$529 EA	Light Gray
ALEHVF1929PY	\$529 EA	Putty

4 Drawer Legal 25" Depth

Overall Size: 18"W x 25"D x 52"H
 Material: Steel
 Shipping Weight: 85 lb

ALEHVF1952BL	\$844 EA	Black
ALEHVF1952LG	\$844 EA	Light Gray
ALEHVF1952PY	\$844 EA	Putty



2 Drawer Letter 25" Depth

Overall Size: 15"W x 25"D x 28.4"H
 Material: Steel
 Shipping Weight: 43 lb

ALEHVF1529BL	\$401 EA	Black
ALEHVF1529LG	\$401 EA	Light Gray
ALEHVF1529PY	\$401 EA	Putty

4 Drawer Letter 25" Depth

Overall Size: 15"W x 25"D x 52"H
 Material: Steel
 Shipping Weight: 74 lb

ALEHVF1552BL	\$656 EA	Black
ALEHVF1552LG	\$656 EA	Light Gray
ALEHVF1552PY	\$656 EA	Putty



Metal Desking & Storage

VERTICAL FILE CABINETS

- The preferred method of storage when floor space is limited.
- Wire follower block keeps files upright.
- High-sided drawers equipped with hang rails for hanging folders.
- Strong aluminum handle and thumb latch.
- Drawers extend fully for easy access.
- Core removable lock allows files to be keyed alike.
- Baked enamel finish.

2 Drawer Letter 26.5" Depth

Overall Size: 15"W x 26.5"D x 28.4"H
 Weight Capacity: 54.4 lb
 Material: Steel
 Shipping Weight: 49 lb

ALEHVF152629BL	\$407 EA	Black
ALEHVF152629LG	\$407 EA	Light Gray
ALEHVF152629PY	\$407 EA	Putty



4 Drawer Letter 26.5" Depth

Overall Size: 15"W x 26.5"D x 52"H
 Weight Capacity: 54.4 lb
 Material: Steel
 Shipping Weight: 84 lb

ALEHVF152652BL	\$684 EA	Black
ALEHVF152652LG	\$684 EA	Light Gray
ALEHVF152652PY	\$684 EA	Putty



5 Drawer Letter 26.5" Depth

Overall Size: 15"W x 26.5"D x 61.4"H
 Weight Capacity: 54.4 lb
 Material: Steel
 Shipping Weight: 101 lb

ALEHVF1562BL	\$959 EA	Black
ALEHVF1562LG	\$959 EA	Light Gray
ALEHVF1562PY	\$959 EA	Putty

Vertical Files

FILE CABINETS



2 Drawer Legal 26.5" Depth

Overall Size: 18"W x 26.5"D x 28.4"H
Material: Steel
Shipping Weight: 53 lb

- ALE14102** \$407 ^{EA}
- ALE14103** \$407 ^{EA}
- ALE14104** \$407 ^{EA}

Putty
Black
Gray



5 Drawer Legal 26.5" Depth

Overall Size: 18"W x 26.5"D x 61.4"H
Material: Steel
Shipping Weight: 110 lb

- ALE17780** \$1010 ^{EA}
- ALE17781** \$1010 ^{EA}
- ALE17782** \$1010 ^{EA}

Putty
Black
Light Gray

2 Drawer Letter 28.5" Depth

Overall Size: 15"W x 28.5"D x 28.4"H
Color: Black
Material: Steel
Shipping Weight: 56 lb

- ALE18770** \$626 ^{EA}



4 Drawer Legal 26.5" Depth

Overall Size: 18"W x 26.5"D x 52"H
Material: Steel
Shipping Weight: 91 lb

- ALE14106** \$844 ^{EA}
- ALE14107** \$844 ^{EA}
- ALE14108** \$844 ^{EA}

Putty
Black
Light Gray



5 Drawer Letter 28.5" Depth

Overall Size: 15"W x 28"D x 61.4"H
Color: Black
Material: Steel
Shipping Weight: 117 lb

- ALE18776** \$1010 ^{EA}



4 Drawer Letter 28.5" Depth

Overall Size: 15"W x 28.5"D x 52"H
Color: Black
Material: Steel
Shipping Weight: 96 lb

- ALE18773** \$950 ^{EA}



Accessories

CADDY

Overall Size: 15"-18"W x 18"-26.5"D x 4"H
Color: Black
Material: Steel
Shipping Weight: 6 lb

- ALE10035**   \$91 ^{EA}



Metal Desking & Storage

Pedestal

Mobile Peds

VERTICAL PEDESTAL FILE CABINETS

- Box drawers include one divider and pencil tray.
- High-sided file drawers include legal conversion bar.
- Counterweight prevents tipping.
- Core-changeable lock.
- Steel ball bearing slide suspension with ¾ extension on box drawers and full-length extension on file drawers.
- 26.5" high if used without casters, 28" high with glides.
- Four casters (two locking) for mobility or four glides for stationary use.



Box/File with Recessed Pull

Overall Size: 15"W x 19.3"D x 21.7"H
 Material: Steel
 Shipping Weight: 65.1 lb

ALEPABFBL	\$408 EA	Black
ALEPABFCH	\$408 EA	Charcoal
ALEPABFLG	\$408 EA	Light Gray
ALEPABFPY	\$408 EA	Putty



Box/Box/File with Recessed Pull

Overall Size: 15"W x 19.3"D x 27.8"H
 Material: Steel
 Shipping Weight: 78.3 lb

ALEPABBFBL	\$480 EA	Black
ALEPABBFCH	\$480 EA	Charcoal
ALEPABBFGL	\$480 EA	Light Gray
ALEPABBFPPY	\$480 EA	Putty



File/File with Recessed Pull

Overall Size: 15"W x 19.3"D x 27.8"H
 Material: Steel
 Shipping Weight: 75.2 lb

ALEPAFFBL	\$453 EA	Black
ALEPAFFCH	\$453 EA	Charcoal
ALEPAFFGL	\$453 EA	Light Gray
ALEPAFFPPY	\$453 EA	Putty



Mobile Peds

VERTICAL PEDESTAL FILE CABINETS

- Box drawers include one divider and pencil tray.
- High-sided file drawers include legal conversion bar.
- Counterweight prevents tipping.
- Core-changeable lock.
- Steel ball bearing slide suspension with ¾ extension on box drawers and full-length extension on file drawers.
- 26.5" high if used without casters, 28" high with glides.
- Four casters (two locking) for mobility or four glides for stationary use.



Box/Box/File with Full Length Recessed Pull

Overall Size: 15"W x 19.3"D x 27.8"H

Material: Steel

Shipping Weight: 76.8 lb

ALEPBBBFBL	\$484 EA	Black
ALEPBBBFCH	\$484 EA	Charcoal
ALEPBBBFLG	\$492 EA	Light Gray
ALEPBBBFPY	\$492 EA	Putty



File/File with Full Length Recessed Pull

Overall Size: 15"W x 19.3"D x 27.8"H

Material: Steel

Shipping Weight: 72.3 lb

ALEPBBFFBL	\$432 EA	Black
ALEPBBFFCH	\$432 EA	Charcoal
ALEPBBFFLG	\$432 EA	Light Gray
ALEPBBFFPY	\$432 EA	Putty



Box/File with Full Length Recessed Pull

Overall Size: 15"W x 19.3"D x 21.7"H

Material: Steel

Shipping Weight: 65.1 lb

ALEPBBBFBL	\$360 EA	Black
ALEPBBBFCH	\$360 EA	Charcoal
ALEPBBBFLG	\$360 EA	Light Gray
ALEPBBBFPY	\$360 EA	Putty



Metal Desking & Storage

Pedestals & Accessories

Pedestal Cushion

PEDESTAL FILE SEAT CUSHION

- Add a cushion to the top of any Alera® Pedestal or Low Credenza for instant seating.
- Soft resilient foam covered in soft long-lasting fabric.
- Rubber grip bottom surface holds cushion in place without slipping; but easily repositionable.
- Two inch thick cushions offer just the right amount of support.

Overall Size: 15"W x 19.1"D x 2.1"H
 Material: Steel
 Shipping Weight: 2.2 lb

ALEPC1511	\$84 EA	Smoke
ALEPC1551	\$84 EA	Tan Quartz



Slim Ped

BOX/FILE SLIM PEDESTAL

Overall Size: 10"W x 20"D x 21.8"H
 Material: Steel
 Shipping Weight: 26 lb

ALE22650	\$490 EA	Black
ALE24044	\$490 EA	Silver



Accessories

LOCK CORE SET FOR METAL FILE PEDESTAL

Easy to install lock for use to key-alike all Alera® Metal Pedestals. Set includes lock core, core removal key and four keys.

Color: Silver
 Shipping Weight: 0.1 lb

ALEKC501111	\$18 ST
--------------------	----------------



Storage Cabinets

OFFICE & ALL-PURPOSE STORAGE CABINETS

- An attractive and durable concealed-storage solution.
- Fully welded steel construction.
- Smooth, nonporous, baked-enamel finish.
- Recessed handles.
- Three-point locking system with lock rods and removable cores.
- All shelves, but the fixed bottom shelf, adjust in 1" increments.
- All shelves support up to 180 lb.



42" Height Economy

Overall Size: 36"W x 18"D x 42"H
Material: Steel
Shipping Weight: 90 lb

ALEHCM4218BK
ALEHCM4218LG
ALEHCM4218PY

\$911 EA Black
\$911 EA Light Gray
\$911 EA Putty



66" Height Economy

Overall Size: 30"W x 15"D x 66"H
Material: Steel
Shipping Weight: 96 lb

ALEHCM6615BK
ALEHCM6615LG
ALEHCM6615PY

\$1064 EA Black
\$1064 EA Light Gray
\$1064 EA Putty

72" Height Economy

Overall Size: 36"W x 18"D x 72"H
Material: Steel
Shipping Weight: 116 lb

ALEHCM7218BK
ALEHCM7218LG
ALEHCM7218PY

\$1323 EA Black
\$1323 EA Light Gray
\$1323 EA Putty



STANDARD ASSEMBLED STORAGE CABINET SERIES

- Industrial grade steel with powder coat finish and polished chrome handle.
- Secure three point locking system locks top, bottom and doors.
- Adjustable shelves adjust in 2" increments.
- Reinforced doors open 180°.

42" Height Standard

Overall Size: 36"W x 18"D x 42"H
Material: Steel
Shipping Weight: 76 lb

ALECFME4218BK
ALECFME4218PY

\$899 EA Black
\$899 EA Putty

72" Height Standard

Overall Size: 36"W x 18"D x 72"H
Material: Steel
Shipping Weight: 123 lb

ALECFME7218BK
ALECFME7218PY

\$1250 EA Black
\$1250 EA Putty



Metal Desking & Storage

Storage

Storage Cabinets

OFFICE & ALL-PURPOSE STORAGE CABINETS

- Shelves adjust in 2" increments.
- Reinforced doors with satin chrome double handles open 180°.
- Secure three-point locking rod system locks top, bottom and doors.
- Industrial-grade steel with powder coat finish for lasting use.



42" Height Heavy-Duty
Overall Size: 36"W x 18"D x 42"H
Material: Steel
Shipping Weight: 92 lb

ALECM4218BK
ALECM4218LG
ALECM4218PY

\$1201 EA Black
\$1201 EA Light Gray
\$1201 EA Putty



72" Height Heavy-Duty
Overall Size: 36"W x 18"D x 72"H
Material: Steel
Shipping Weight: 145 lb

ALECM7218BK
ALECM7218LG
ALECM7218PY

\$1587 EA Black
\$1587 EA Light Gray
\$1587 EA Putty



78" Height Heavy-Duty
Overall Size: 36"W x 24"D x 78"H
Material: Steel
Shipping Weight: 178 lb

ALECM7824BK
ALECM7824LG
ALECM7824PY

\$1756 EA Black
\$1756 EA Light Gray
\$1756 EA Putty

SPACE SAVER SERIES

Designed for use where space is at a premium! Depth is narrower to allow use in tight areas. Shorter height is ideal for use next to panel systems. Built tough to ensure strength and durability. Recessed locking handle. Secure three-point locking system locks top, bottom and doors.

66" Height Spacesaver
Overall Size: 30"W x 15"D x 66"H
Material: Steel
Shipping Weight: 75 lb

ALECM6615BK
ALECM6615PY

\$1407 EA Black
\$1407 EA Putty



Mobile Storage Cabinets

ASSEMBLED MOBILE STORAGE CABINET SERIES

Fully enclosed, industrial grade welded steel cabinets hold up to 900 lbs. Secure three-point locking bar system locks top, bottom and doors. Reinforced doors with recessed handles open 180°. Heavy-duty caster base has four 5" casters, two locking.

66" Height Mobile
Overall Size: 36"W x 24"D x 66"H
Material: Steel
Shipping Weight: 162 lb

ALECM6624BK
ALECM6624PY

\$1912 EA Black
\$1912 EA Putty



Storage Cabinets

- Adjustable shelves (1" increments).
- Core-removable lock
- Fully assembled welded construction.
- Easily cleaned painted steel surfaces.



Wardrobe Combo

Overall Size: 36"W x 18"D x 72"H
Material: Steel
Shipping Weight: 116 lb

- | | | |
|-----------------|------------------|-------|
| ALE22754 | \$1163 EA | Putty |
| ALE22755 | \$1163 EA | Black |
| ALE22756 | \$1163 EA | Gray |



Jan/San

Overall Size: 36"W x 18"D x 72"H
Material: Steel
Shipping Weight: 103 lb

- | | | |
|-----------------|------------------|-------|
| ALE24096 | \$1257 EA | Putty |
| ALE24097 | \$1257 EA | Black |
| ALE24098 | \$1257 EA | Gray |



Personal Storage

Overall Size: 30"W x 18.3"D x 28"H
Color: Black
Material: Steel
Shipping Weight: 118 lb

- | | |
|-----------------|------------------|
| ALE19628 | \$1885 EA |
|-----------------|------------------|



Wardrobe

Overall Size: 36"W x 18"D x 72"H
Material: Steel
Shipping Weight: 116 lb

- | | | |
|-----------------|------------------|-------|
| ALE24314 | \$1233 EA | Putty |
| ALE24315 | \$1233 EA | Black |
| ALE24316 | \$1233 EA | Gray |

Accessories



Lateral File and Storage Cabinet Dolly

Overall Size: 30"-44"W x 18"-24"D x 4"H
Color: Black
Material: Steel
Shipping Weight: 21 lb

- | | |
|-----------------|-----------------|
| ALE15030 | \$294 EA |
|-----------------|-----------------|

Metal Desking & Storage

Storage

BOOKCASES



- Contemporary design is ideal for any workspace.
- Shelves adjust in 1" increments.
- 200 lb weight capacity.
- Fully assembled welded construction.



Two-Shelf, one adjustable

Overall Size: 34.5"W x 13"D x 30"H
Material: Steel
Shipping Weight: 36.3 lb

- ALE21200**
- ALE21201**
- ALE21202**
- ALE22194**

- \$400** EA Putty
- \$400** EA Black
- \$400** EA Gray
- \$400** EA Charcoal



Five-Shelf, four adjustable

Overall Size: 34.5"W x 13"D x 72"H
Material: Steel
Shipping Weight: 71.5 lb

- ALE21209**
- ALE21210**
- ALE21211**
- ALE22197**

- \$738** EA Putty
- \$738** EA Black
- \$738** EA Gray
- \$738** EA Charcoal



Three-Shelf, two adjustable

Overall Size: 34.5"W x 13"D x 42"H
Material: Steel
Shipping Weight: 47 lb

- ALE21203**
- ALE21204**
- ALE21205**
- ALE22195**

- \$476** EA Putty
- \$476** EA Black
- \$476** EA Gray
- \$476** EA Charcoal



Four-Shelf, three adjustable

Overall Size: 34.5"W x 13"D x 60"H
Material: Steel
Shipping Weight: 60.8 lb

- ALE21206**
- ALE21207**
- ALE21208**
- ALE22196**

- \$652** EA Putty
- \$652** EA Black
- \$652** EA Gray
- \$652** EA Charcoal



Six-Shelf, four adjustable

Overall Size: 34.5"W x 13"D x 82"H
Material: Steel
Shipping Weight: 81.1 lb

- ALE21212**
- ALE21213**
- ALE21214**
- ALE22198**

- \$862** EA Putty
- \$862** EA Black
- \$862** EA Gray
- \$862** EA Charcoal

Light-Duty Residential

RESIDENTIAL WIRE SHELVING SERIES

- An economical storage solution for light duty applications.
- Snap-together design assembles in minutes.
- Strong welded wire construction provides exceptional strength and stability.
- Open design allows air circulation and reduces dust build-up.
- Holds up to 250 lbs. per shelf (evenly distributed).

3-Shelf

Overall Size: 36"W x 14"D x 36"H
 Weight Capacity: 750 lbs
 Color: Silver
 Material: Steel
 Shipping Weight: 21.7 lb

ALESW833614SR \$137 EA



4-Shelf

Overall Size: 36"W x 14"D x 54"H
 Weight Capacity: 1,000 lbs
 Color: Silver
 Material: Steel
 Shipping Weight: 29.3 lb

ALESW843614SR \$192 EA

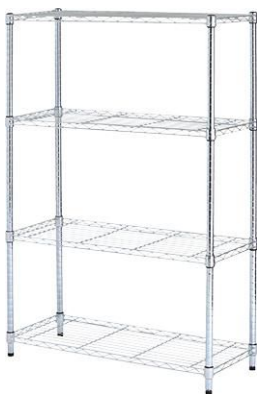

5-Shelf

Overall Size: 36"W x 14"D x 72"H
 Weight Capacity: 1,250 lbs
 Color: Silver
 Material: Steel
 Shipping Weight: 36.6 lb

ALESW853614SR \$238 EA



Medium-Duty Commercial

COMMERCIAL WIRE SHELVING WITH CASTER SERIES

- Ideal storage solution for all your medium-duty commercial storage requirements.
- Snap-together design assembles in minutes.
- Strong welded wire construction provides exceptional strength and stability.
- Open design allows air circulation and reduces dust build-up.
- Up to 600 lbs. per shelf (evenly distributed) when used without casters.
- Casters (2 locking) provide mobility and can be omitted to increase weight capacity of unit.

4-Shelf

Overall Size: 48"W x 18"D x 72"H
 Material: Steel
 Shipping Weight: 54.1 lb

ALESW604818BA	\$302 EA	Black Anthracite
ALESW604818BL	\$302 EA	Black
ALESW604818SR	\$302 EA	Silver



5-Shelf

Overall Size: 36"W x 18"D x 72"H
 Weight Capacity: 3,000 lbs
 Material: Steel
 Shipping Weight: 56.8 lb

ALESW653618BA	\$318 EA	Black Anthracite
ALESW653618SR	\$318 EA	Silver
ALESW654818BA	\$382 EA	Black Anthracite
ALESW654818SR	\$382 EA	Silver



6-Shelf

Overall Size: 48"W x 18"D x 72"H
 Weight Capacity: 3,600 lbs
 Material: Steel
 Shipping Weight: 69.8 lb

ALESW664818BA	\$386 EA	Black Anthracite
ALESW664818BL	\$386 EA	Black
ALESW664818SR	\$386 EA	Silver



Metal Desking & Storage

Wire Shelving

Heavy-Duty Industrial

BLACK ANTHRACITE

- Ideal storage solution for your heavy-duty storage requirements.
- Black Anthracite finish is National Sanitation Foundation (NSF) certified for wet and dry environments.
- Open design that allows for air circulation.
- Snap-together design assembles in minutes.
- Can be set up as a four-tier single rack or as two two-tier racks to meet specific needs.
- Shelves adjust in 1" increments.



Black Anthracite 18" Depth

Overall Size: 36"W x 18"D x 72"H
 Weight Capacity: 5,000 lbs
 Material: Steel
 Shipping Weight: 59.6 lb

ALESW503618BA **\$329** EA

Overall Size: 48"W x 18"D x 72"H
 Weight Capacity: 5,000 lbs
 Color: Black Anthracite
 Material: Steel
 Shipping Weight: 71.5 lb

ALESW504818BA **\$387** EA

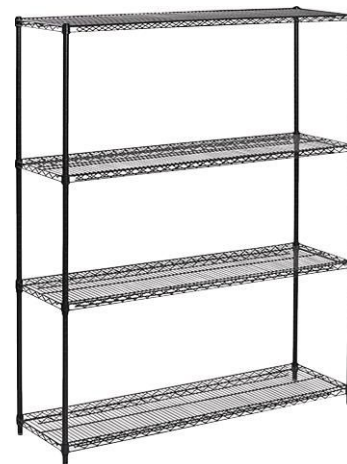

Black Anthracite Plus 18" Depth

Overall Size: 60"W x 18"D x 72"H
 Weight Capacity: 4,000 lbs
 Material: Steel
 Shipping Weight: 85.1 lb

ALESW206018BA **\$524** EA

Overall Size: 72"W x 18"D x 72"H
 Weight Capacity: 4,000 lbs
 Color: Black Anthracite
 Material: Steel
 Shipping Weight: 96 lb

ALESW207218BA **\$617** EA



Black Anthracite 24" Depth

Overall Size: 36"W x 24"D x 72"H
 Weight Capacity: 4,000 lbs
 Material: Steel
 Shipping Weight: 64.9 lb

ALESW503624BA **\$359** EA

Overall Size: 24"W x 24"D x 72"H
 Weight Capacity: 4,000 lbs
 Color: Black Anthracite
 Material: Steel
 Shipping Weight: 79.4 lb

ALESW504824BA **\$432** EA



Black Anthracite Plus 24" Depth

Overall Size: 60"W x 24"D x 72"H
 Weight Capacity: 4,000 lbs
 Material: Steel
 Shipping Weight: 102.1 lb

ALESW206024BA **\$613** EA

Overall Size: 72"W x 24"D x 72"H
 Weight Capacity: 4,000 lbs
 Color: Black Anthracite
 Material: Steel
 Shipping Weight: 117 lb

ALESW207224BA **\$713** EA

Heavy-Duty Industrial

STARTER KIT

- Ideal storage solution for your heavy-duty storage requirements.
- Snap-together design assembles in minutes.
- Can be set up as a four-tier single rack or as two two-tier racks to meet specific needs.
- Open design allows air circulation and reduces dust build-up.
- Shelves adjust in 1" increments.



Starter Kit 18" Depth

Overall Size: 36"W x 18"D x 72"H
 Weight Capacity: 5,000 lbs
 Material: Steel
 Shipping Weight: 59.6 lb

ALESW503618BL \$329 EA Black
ALESW503618SR \$329 EA Silver



Starter Kit 24" Depth

Overall Size: 36"W x 24"D x 72"H
 Weight Capacity: 4,000 lbs
 Material: Steel
 Shipping Weight: 64.9 lb

ALESW503624BL \$359 EA Black
ALESW503624SR \$359 EA Silver

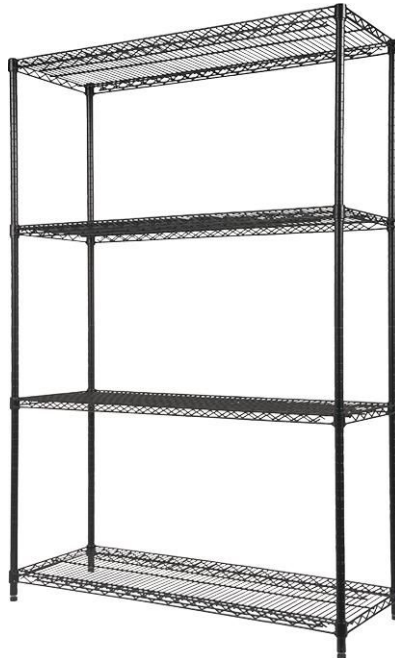

Starter Kit 18" Depth

Overall Size: 48"W x 18"D x 72"H
 Weight Capacity: 5,000 lbs
 Material: Steel
 Shipping Weight: 71.5 lb

ALESW504818BL \$387 EA Black
ALESW504818SR \$387 EA Silver



Starter Kit 24" Depth

Overall Size: 48"W x 24"D x 72"H
 Weight Capacity: 4,000 lbs
 Material: Steel
 Shipping Weight: 79.4 lb

ALESW504824BL \$432 EA Black
ALESW504824SR \$432 EA Silver

Metal Desking & Storage

Wire Shelving

Wire Shelving Accessories

SHELVES

- Add extra shelves to existing units, build your own customized unit, or add on shelf extensions with these shelves.
- Strong welded wire shelves provide exceptional strength and stability.
- Snap-together design assembles in minutes.
- Open design allows air circulation and reduces dust build-up.
- Includes two shelves with shelf lock clips.
- 2 shelves per carton.

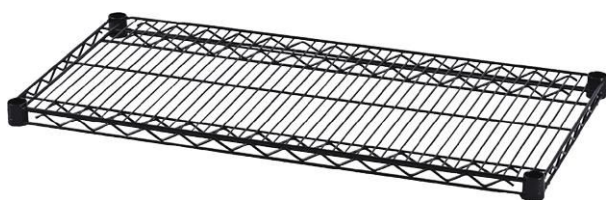

Overall Size: 36"W x 18"D
Material: Steel
Shipping Weight: 23.5 lb

ALESW583618BL \$128 CT Black
ALESW583618SR \$128 CT Silver

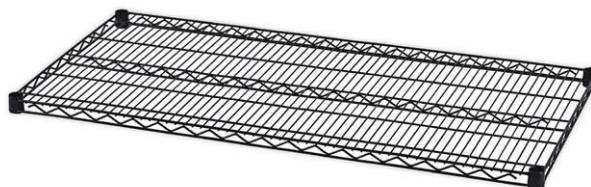

Overall Size: 48"W x 24"D
Material: Steel
Shipping Weight: 34.3 lb

ALESW584824BL \$146 CT Black
ALESW584824SR \$146 CT Silver

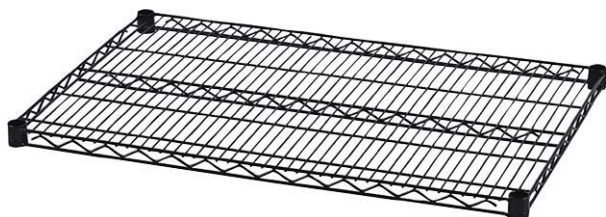

Overall Size: 36"W x 24"D
Material: Steel
Shipping Weight: 26.2 lb

ALESW583624BL \$129 CT Black
ALESW583624SR \$129 CT Silver

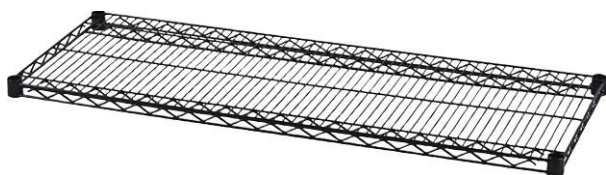

Overall Size: 48"W x 18"D
Material: Steel
Shipping Weight: 30.4 lb

ALESW584818BL \$160 CT Black
ALESW584818SR \$160 CT Silver

Wire Shelving Accessories

POST

- Allows you to easily add on shelves or half-height shelf units.
- Levelers for uneven floors.
- Combine two posts for 72" high shelving.



Overall Size: 36"H
Material: Steel
Shipping Weight: 8.5 lb

ALESW59PO36BL    \$59 PK Black
ALESW59PO36SR    \$59 PK Silver

Wire Shelving Accessories

CASTERS

- Helps make moving wire shelving easy.
- Compatible with Alera® wire shelving racks, sold separately.
- Wheels may be locked for stability.
- Using casters may reduce load capacity for the shelving unit.
- 4 wheels per set.



Overall Size: 3" Wheel
Weight Capacity: 500 lb (125 lb Per Caster)
Material: Steel
Shipping Weight: 4.7 lb

ALESW790004 \$34 ST Black/Silver

Overall Size: 4" Wheel
Weight Capacity: 800 lb (200 lb Per Caster)
Material: Steel
Shipping Weight: 4.7 lb

ALESW690004 \$40 ST Black/Silver

Overall Size: 5" Wheel
Weight Capacity: 2,400 lb (600 lb Per Caster)
Material: Steel
Shipping Weight: 11 lb

ALESW590004 \$84 ST Black/Silver

HOOK BAR

- Handy hook bars hold garments, bags, utensils and supplies.
- Attaches easily to matching-sized wire shelves.
- 2 bars per pack.



Overall Size: 18"W
Material: Steel
Shipping Weight: 2.3 lb

ALESW59HB418SR \$26 ^{PK} Silver

Overall Size: 24"W
Material: Steel
Shipping Weight: 11 lb

ALESW59HB424SR \$31 ^{PK} Black

SHELF TAG

- Shelf tags keep everything organized.
- Easy to snap on tags.
- Fits all standard Alera® Wire Shelves.
- 10 tags per pack.

Overall Size: 3"W
Color: Gray
Material: Plastic
Shipping Weight: 0.4 lb

ALESW59ST   \$11 ^{PK}



S-HOOK

- Use to secure multiple shelving units together.
- Constructed to stand up to daily wear-and-tear.
- 4 hooks per pack.



Material: Steel
Shipping Weight: 0.3 lb

ALESW59SHBL \$12 ^{PK} Black
ALESW59SHSR \$12 ^{PK} Silver

SHELF LOCK CLIPS

- Locks down shelving securely.
- Constructed to stand up to daily wear-and-tear.

Overall Size: 1"x1"x1.5"
Color: Black
Material: Plastic
Shipping Weight: 0.1 lb

ALESW59SLBL    \$8 ^{PK}



SHELF LINERS

- Flexible, crystal clear, and easy to clean.
- For use over matching sized wire shelves.
- Ideal for small item storage.
- Protects shelves from spills, dirt, and dust.
- 4 liners per pack.

Overall Size: 36"W x 18"D
Material: Plastic
Shipping Weight: 2.9 lb

ALESW59SL3618 \$50 ^{PK} Clear

Overall Size: 36"W x 24"D
Material: Plastic
Shipping Weight: 3.7 lb

ALESW59SL3624 \$74 ^{PK} Clear

Overall Size: 48"W x 18"D
Material: Steel
Shipping Weight: 3.7 lb

ALESW59SL4818 \$70 ^{PK} Clear

Overall Size: 48"W x 24"D
Material: Plastic
Shipping Weight: 5.2 lb

ALESW59SL4824 \$92 ^{PK} Clear



Metal Desking & Storage

Shelving

Shelving

SHELVING SERIES

- Riveted steel construction.
- Shelves adjust in 1.5" increments to accommodate items of varying heights.
- Assembles vertically or horizontally.
- Assembles with a rubber mallet (not included).
- Durable powder-coated finish is rust resistant.
- Steel frame and black laminate shelves.

3200 Series Laminate Shelves

Overall Size: 36"W x 18"D x 60"H
 Weight Capacity: 2,560 lbs
 Color: Black
 Material: Steel/Laminate
 Shipping Weight: 46 lb

ALESU601836L \$310 EA

Overall Size: 36"W x 18"D x 72"H
 Weight Capacity: 3,200 lbs
 Color: Black
 Material: Steel/Laminate
 Shipping Weight: 56 lb

ALESU721836L \$345 EA



3800 Series Particleboard Shelves

Overall Size: 30"W x 16"D x 60"H
 Weight Capacity: 2,560 lbs
 Color: Black
 Material: Steel/Particleboard
 Shipping Weight: 51 lb

ALESU601630P \$251 EA

3800 Series Particleboard Shelves

Overall Size: 36"W x 18"D x 72"H
 Weight Capacity: 3,200 lbs
 Color: Black
 Material: Steel/Particleboard
 Shipping Weight: 77 lb

ALESU721836P \$287 EA

3800 Series Particleboard Shelves

Overall Size: 48"W x 24"D x 84"H
 Weight Capacity: 3,200 lbs
 Color: Black
 Material: Steel/Particleboard
 Shipping Weight: 137 lb

ALESU842448P \$409 EA

File Carts

FILING CARTS

- Keep paperwork handy when you need it and out of the way when you don't.
- Bottom shelf adjusts in 1" increments.
- Wheels glide with ease for mobility and lock for stability.
- Strong lower shelf supports up to 150 lbs.
- Assembles without tools.

Compact File Cart for Side-to-Side Filing

Overall Size: 15.3"W x 12.4"D x 21"H
 Color: Black
 Material: Steel
 Shipping Weight: 8.3 lb
ALEFW601416BL \$76 EA



One-Tier File Cart for Side-to-Side Filing

Overall Size: 24"W x 14"D x 21"H
 Color: Black
 Material: Steel
 Shipping Weight: 11.4 lb
ALEFW601424BL \$81 EA



Two-Tier File Cart for Front-to-Back + Side-to-Side Filing

Overall Size: 26"W x 14"D x 29.5"H
 Color: Black
 Material: Steel
 Shipping Weight: 16.9 lb
ALEFW601426BL \$120 EA



KITCHEN CARTS

- Ideal for a variety of applications, from food-service stock rooms to mail rooms.
- Shelves adjust in 1" increments.
- Push/pull handle and swivel casters.
- Includes three shelf liners.
- Easy to assemble—no tools required.

Three-Shelf Wire Cart with Liner

Overall Size: 24"W x 16"D x 39"H
 Weight Capacity: 450 lb
 Color: Silver
 Material: Steel
 Shipping Weight: 23.1 lb
ALESW322416SR \$135 EA



Overall Size: 34.5"W x 18"D x 40"H
 Weight Capacity: 600 lb
 Color: Silver
 Material: Steel
 Shipping Weight: 26.2 lb
ALESW333018SR \$160 EA

Three-Tier Wire Cart with Basket



Overall Size: 28"W x 16"D x 39"H
 Weight Capacity: 500 lb
 Color: Black Anthracite
 Material: Steel
 Shipping Weight: 25.5 lb
ALESW342416BA \$138 EA



Overall Size: 34"W x 18"D x 40"H
 Weight Capacity: 500 lb
 Color: Black Anthracite
 Material: Steel
 Shipping Weight: 40.5 lb
ALESW543018BA \$206 EA

MAIL CARTS

Ideal carry-all mobile cart. Use to haul mail, packages, boxes, and files around the office. Top basket can accommodate letter and legal size hanging folders.

Overall Size: 35"W x 18"D x 39.5"H
 Weight Capacity: 500 lb
 Color: Silver
 Material: Steel
 Shipping Weight: 28.6 lb
ALEMC3518SR    \$190 EA



Metal Desking & Storage

Storage

Garment Racks

WIRESHELVING GARMENT RACK

- Strong welded wire construction.
- Double-sided access.
- Assembles in minutes, no tools required.
- Rack includes hanging rod for garments, and five support hooks for umbrellas, bags, and other items.
- Three shelves adjust in 1" increments and support 350 lbs. each.
- Total unit capacity is 500 lbs. if used with casters.
- Open design allows air circulation and prevents dust buildup.

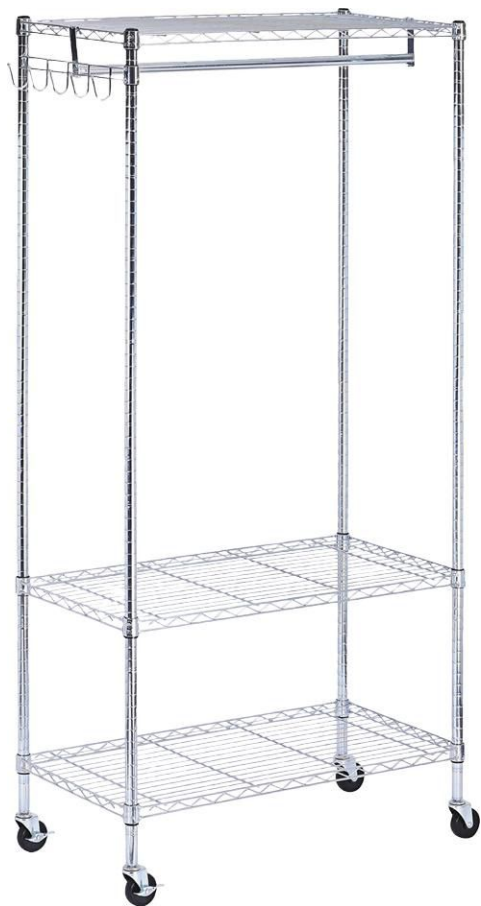

Overall Size: 36"W x 18"D x 75"H
Material: Steel
Shipping Weight: 35.4 lb

ALEGR363618BL **\$162** EA Black
ALEGR363618SR **\$162** EA Silver

GARMENT HOOK

- Wire hook makes use of wall space to store coats, hats, accessories or office items.
- Hooks slides over cubicle walls, partitions or doors with ease.
- Strong construction holds even the bulkiest coats.
- Fits over panels 1.5" to 2.5" thick.
- 2 hooks per pack.



Color: Silver
Material: Steel
Shipping Weight: 0.3 lb

Single Sided Partition
Overall Size: 0.5"W x 3.1"D x 4.8" H

ALECH1SR **\$11** PK

Double Sided Partition
Overall Size: 0.5"W x 3.4"D x 4.8"H

ALECH2SR **\$10** PK



Overall Size: 48"W x 18"D x 75"H
Material: Steel
Shipping Weight: 43.6 lb

ALEGR364818BL **\$186** EA Black
ALEGR364818SR **\$186** EA Silver

SINGLE PEDESTAL STEEL DESK SERIES



- Full extension on all drawers.
- Precision ball-bearing drawer slide.
- Central lock system locks all drawers.
- Extended drawer fronts with full-width pull.
- Durable laminate wood work surface is easy to clean and disinfect.
- Leveling glides adjust for uneven floors.



Overall Size: 45"W x 24"D x 29.5"H
 Weight Capacity: 200 lb
 Material: Steel/Laminate
 Shipping Weight: 106 lb

ALEHSD4524BM
ALEHSD4524CM
ALEHSD4524PC

\$1176 EA Mocha/Black
\$1176 EA Mahogany/Charcoal
\$1176 EA Cherry/Putty

DOUBLE PEDESTAL STEEL DESK SERIES



- Durable steel construction with non-porous surface is easy to clean.
- Central lock system locks all drawers.
- Full extension on file and box drawers.
- Durable laminate wood work surface is easy to clean and disinfect.
- Extended drawer fronts with full-width pull.
- Legs include leveling guides.



Overall Size: 60"W x 30"D x 29.5"H
 Weight Capacity:
 Material: Steel/Laminate
 Shipping Weight: 157 lb

ALE19915 **\$1757** EA Gray
ALE24339 **\$1757** EA Maple/Black

Overall Size: 60"W x 30"D x 29.5"H
 Weight Capacity: 200 lb
 Material: Steel/Laminate
 Shipping Weight: 157 lb

ALEHSD6030BM
ALEHSD6030CM
ALEHSD6030PC

\$1757 EA Mocha/Black
\$1757 EA Mahogany/Charcoal
\$1757 EA Cherry/Putty

Metal Desking & Storage

Metal Desking

L-Shaped Desk

HAND RETURN



Left Hand Return

Overall Size: 66"W x 30"D x 29.5"H
Material: Steel
Shipping Weight: 299 lb

ALE20107	2570 EA	Putty / Oak
ALE20108	2570 EA	Black/ Walnut
ALE20109	2570 EA	Charcoal/Mahogany



Right Hand Return

Overall Size: 66"W x 30"D x 29.5"H
Material: Steel
Shipping Weight: 299 lb

ALE20104	2570 EA	Putty / Oak
ALE20105	2570 EA	Black/ Walnut
ALE20106	2570 EA	Charcoal/Mahogany

Single Ped

MODERN TEACHER SERIES

- Durable laminate worksurface—easy to clean and disinfect.
- T-mold edges and corners promote safety.
- Full-height pedestal with locking drawers.
- Acrylic modesty panel for privacy.
- Hidden swivel casters under the pedestal and locking swivel casters under the t-leg.



Overall Size: 60"W x 24"D x 28.8"H
Material: Laminate/Steel
Shipping Weight: 185 lb

ALEMSD6024CH	\$1904 EA	Charcoal Woodgrain/Gray
ALEMSD6024WH	\$1904 EA	White/Silver

Double Ped

EXECUTIVE DESK



60 x 30 with full side panel

Overall Size: 60"W x 30"D x 29.5"H
Material: Steel
Shipping Weight: 182 lb

ALE24992	\$2261 EA	Black/Walnut
ALE24993	\$2261 EA	Charcoal/Mahogany



72 x 36 with full side panel

Overall Size: 72"W x 36"D x 29.5"H
Material: Steel
Shipping Weight: 224 lb

ALE24990	\$2508 EA	Black/Walnut
ALE24991	\$2508 EA	Charcoal/Mahogany

Low Credenza

LATERAL CABINET



36" Wide with Sliding Door

Overall Size: 36"W x 18.6"D x 22"H
Material: Steel
Shipping Weight: 77 lb

ALE20506	\$1074 EA	Black
ALE20507	\$1074 EA	Charcoal



36" Wide Lateral Cabinet

Overall Size: 36"W x 18.6"D x 22"H
Material: Steel
Shipping Weight: 77 lb

ALE20508	\$1034 EA	Black
ALE20509	\$1034 EA	Charcoal

Accessories

Final touches for your office space.



Elevate your office with our curated collection of accessories, designed to add the perfect finishing touches to your workspace. From lamps to fans and fridges, these must-have items, combine functionality with flair to help you stay productive and organized. These thoughtful additions not only improve efficiency, but provide comfort and make it a place where you can truly focus and thrive. Discover the office essentials you can't work without and the final touches that bring your workspace to life.

- SOHO Furniture 91
- Lamps 92
- Fans 93
- Heaters 94
- Refrigerators 94

SOHO

Desks

DESKS SIT-TO-STAND TABLE DESK

Ultimate versatile workspace easily transitions from a sitting to standing desk. Great for any workspace, multi-function design takes up minimal space. Lift portion of the desk surface has infinite height adjustability that can be locked in several positions within a 14" range. Lift portion easily returns to seated height and remains flush with top surface. Stylish tapered legs with leveling glides to adjust for uneven floors.

Table Desk

Overall Size: 47.3"W x 23.6"D x 29.5" to 43.8"H
 Color: Modern Walnut
 Material: Laminate
 Shipping Weight: 74.8 lb

ALELD4824WA \$791 EA



INDUSTRIAL SERIES

Writing desk perfect for the home or small office. Scratch resistant laminate top with squared steel powder coated legs. Cross-stability bar to prevent rocking and to ensure a stable feel. Leveling glides included to adjust for uneven floors.

Table Desk

Overall Size: 47.3"W x 23.6"D x 29.5"H
 Color: Modern Walnut
 Material: Laminate Top & Steel Legs
 Shipping Weight: 51.7 lb

ALELTD4824WA \$333 EA



Vertical Files

SOHO CABINET SERIES



Organize your home or professional workspace with light duty vertical file cabinets. Keep all your letter-sized documents secure and tucked away in 18" depth drawers. This file cabinet comes equipped with one factory installed lock and key, controlling file drawers for peace of mind and security. The sleek finish and polished handles keep your office space looking contemporary and organized.



2 Drawers File/File

Overall Size: 14"W x 18"D x 24.1"H
 Material: Steel
 Shipping Weight: 28.7 lb

ALESVF1824BL \$255 EA Black
ALESVF1824CH \$255 EA Charcoal
ALESVF1824PY \$255 EA Putty

3 Drawers File/File/File

Anti-tipping wall anchor for additional safety
 Overall Size: 14"W x 18"D x 34.9"H
 Color: Black
 Material: Steel
 Shipping Weight: 41.2 lb

ALESVF1835BL \$285 EA



3 Drawers Pencil/File/File

Anti-tipping wall anchor for additional safety
 Overall Size: 14"W x 18"D x 26.9"H
 Color: Charcoal
 Material: Steel
 Shipping Weight: 34.8 lb

ALESVF1827CH \$231 EA



Lamps

TABLE LAMP

Sleek and modern designs provide the perfect balance of functionality and aesthetics. Brighten your day and transform your workspace with our stylish desk lighting solutions.



Architect Desk Lamp

Overall Size: 6.8"W x 11.5"D x 22"H
Color: Black
Lamp Shade Material: Metal
Shipping Weight: 5.9 lb
13W CFL bulb is included

ALELMP603B **\$83 EA**



LED Desk Lamp With Interchangeable Base Or Clamp

Overall Size: 5.1"W x 21.8"D x 21.8"H
Color: Black
Shipping Weight: 4.1 lb

ALELED902B **\$111 EA**



Twin-Arm Task LED Lamp with USB Port

Overall Size: 11.9"W x 5.1"D x 18.5"H
Color: Black
Shipping Weight: 3.2 lb

ALELED912B **\$110 EA**



Task Lamp

Overall Size: 6"W x 7.5"D x 16"H
Color: Black
Lamp Shade Material: Metal
Shipping Weight: 3.1 lb
13W CFL bulb is included

ALELMP832B **\$68 EA**



LED Task Lamp

Overall Size: 5.4"W x 9.9"D x 17"H
Color: Black
Shipping Weight: 2.2 lb

ALELED931B **\$73 EA**



Adjustable LED Desk Lamp

Overall Size: 3.3"W x 6"D x 21.5"H
Color: Black
Lamp Shade Material: Plastic
Shipping Weight: 3.2 lb

ALELED908B **\$119 EA**



LED Desktop Magnifier (1.75X) Lamp With Interchangeable Base Or Clamp

Overall Size: 6.9"W x 16.6"D x 16.8"H
Color: Black
Shipping Weight: 4.6 lb

ALELEDM765B **\$120 EA**

BANKER'S LAMP

Classic design adds sophistication and elegance to any office, study, or home den. Refined glass shade rotates to pilot light direction. Classic pull chain for easy on/off power. 13W CFL bulb is included.



Banker's Lamp

Overall Size: 10"W x 13.4"D x 16"H
Color: Antique Bronze/Amber
Lamp Shade Material: Glass
Shipping Weight: 7 lb
13W CFL bulb is included

ALELMP537BZ **\$136 EA**



Banker's Lamp

Overall Size: 10.5"W x 11"D x 13"H
Color: Antique Brass/Green
Lamp Shade Material: Glass
Shipping Weight: 5.5 lb
13W CFL bulb is included

ALELMP557AB **\$122 EA**



FLOOR LAMP

Light up the whole room with upward facing shade. Frosted white shade with black metal base blends seamlessly into any space. Three-way rotary switch accommodates three-way style bulbs. 3-way 4W/9W/15W LED bulb included.

Floor Lamp

Overall Size: 11.3"W x 10"D x 71" H
Color: Matte Black/Frosted White
Lamp Shade Material: Plastic
Shipping Weight: 10.8 lb

ALELMPF72B **\$150 EA**

Accessories

Fans

TABLE FAN

12" 3-Speed Oscillating Desk Fan

Color: White
 Material: Plastic
 Shipping Weight: 5.8 lb
ALEFAN122W \$91 EA



16" Super-Circulation 3-Speed Tilt Fan

Color: Black
 Material: Plastic
 Shipping Weight: 7.3 lb
ALEFAN163 \$127 EA

20" Super-Circulator 3-Speed Tilt Fan

Color: Black
 Material: Plastic
 Shipping Weight: 8.8 lb
ALEFAN203 \$138 EA



BOX FAN

Slimprofile box fan takes up less space than conventional designs. Lightweight but stable base design ensures it is easy to setup anywhere. Features three-speed settings and a convenient integrated carry-handle. Large rotary knob for easy adjustments.

3-Speed Box Fan

Overall Size: 20.5"W x 4.1"D x 21.6"H
 Color: Black
 Material: Plastic
 Shipping Weight: 7.8 lb
ALEFANBX20B \$101 EA



PEDESTAL STAND FAN

Height adjustable stand (42" to 49") gets air where you need it most. Tilting and oscillating functions circulates air effectively in most medium and large rooms. 3-speed settings for low, medium, or high fan speeds. Carry handle to easily reposition. Wide disk base for solid stability.

16" 3-Speed Oscillating Pedestal Stand Fan

Color: Black
 Material: Metal & Plastic
 Shipping Weight: 13.1 lb
ALEFANP16B \$124 EA

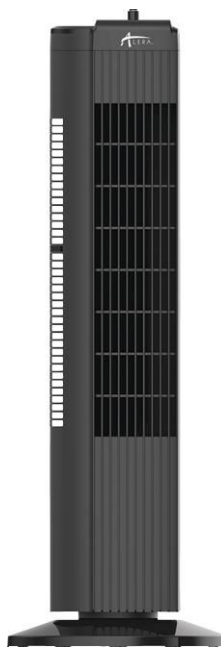

TOWER FAN

28" 3-Speed Oscillating Tower Fan

Color: Black
 Material: Plastic
 Shipping Weight: 7.5 lb
ALEFAN283 \$110 EA

36" 3-Speed Oscillating Tower Fan with Remote Control

Color: Black
 Material: Plastic
 Shipping Weight: 9.9 lb
ALEFAN363 \$181 EA



Heaters

HEATER FAN

Ceramic Heater 1,500 W

Overall Size: 7.1"W x 5.9"D x 8.8"H
Color: Black
Shipping Weight: 3.2 lb

ALEHECH09 **\$107 EA**



Heater Fan 1,500 W

Overall Size: 8.2"W x 4.4"D x 9.5"H
Color: Black
Shipping Weight: 2.5 lb

ALEHEFF10B **\$75 EA**

360-Degree Heater Fan 750 W

Overall Size: 8"W x 8"D x 12"H
Color: Black
Shipping Weight: 5.1 lb

ALEHEFF360B **\$134 EA**



MINI TOWER HEATER

Oscillating mini-tower heater delivers heat where you need it. Air is warmed as it passes over a large ceramic and aluminum heating element. Heat is dispersed by a powerful fan. Adjustable thermostat up to 1500 watt heating output for maximum comfort. Designed with safety in mind with overheat auto-shut off protection, tip-over safety switch, and a cool-to-the-touch plastic housing.

Mini Tower Heater

Overall Size: 7.4"W x 7.4"D x 17.4"H
Color: Black
Shipping Weight: 5.4 lb

ALEHECT17 **\$145 EA**



TOWER HEATER

Oscillating tower heater is perfect to heat up your room or office. Programmable digital thermostat can be set to your ideal temperature. Up to 1500-watt heating output at maximum performance. Auto-off timer up to 8 hours. Designed with safety in mind with overheat auto shut-off protection, tip-over switch, and cool-to-the-touch plastic housing.

Tower Heater

Overall Size: 7.2"W x 7.2"D x 23"H
Color: Black
Shipping Weight: 6.6 lb

ALEHECT24 **\$172 EA**

Refrigerator

BEVERAGE COOLER

Sleek, stainless steel and black beverage cooler keeps beverages cool and accessible. Convenient triple layer, frost-free glass front door. Three adjustable shelves provide plenty of storage. Holds up to 120 cans. Reversible doors can be installed left or right to fit any configuration. Full-range temperature control; interior light. Quiet, low-energy consumption refrigerator/cooler is perfect in any space.

3.4 Cu. Ft. Beverage Cooler

Overall Dimensions: 19.4"W x 17.1"D x 33.1"H
Color: Stainless Steel/Black
Material: Stainless Steel/Metal/Glass
Shipping Weight: 56.2 lb

ALERFBC34 **\$995 EA**



1.6 Cu. Ft. Refrigerator with Chiller Compartment

Overall Dimensions: 18.6"W x 17.8"D x 19.4"H
Color: Black
Shipping Weight: 37.5 lb

ALERF616B **\$487 EA**

REFRIGERATOR

3.2 Cu. Ft. Refrigerator with Chiller Compartment

Overall Dimensions: 18.6"D x 17.7" W x 33.9" H
Color: Black
Shipping Weight: 51.8 lb

ALERF333B **\$639 EA**





ANSI/BIFMA Certification ANSI/BIFMA certified furniture meets high standards for indoor air quality as well as safety and ergonomics in order to minimize health hazards and make injury less likely. Specific performance tests were developed by the Business and Institutional Furniture Manufacturer's Association (BIFMA) and approved by the American National Standards Institute (ANSI). These tests determine the stamina of casegoods and seating in their day-to-day use on a single work shift over ten years under both normal-use and excessive-use conditions.

level™ "requirements" A product must first meet six mandatory prerequisites across the four elements and then accumulate points within each element, including product-related points, to determine its level. For more information, go to: www.levelcertified.org

To achieve level™ 1:

- conform with all six prerequisites
- accumulate between 32 and 44 total points; at least 5 of the total points must be "product" related points for level™ 1 certification

To achieve level™ 2:

- conform with all six prerequisites
- accumulate between 45 and 62 total points; at least 11 of the total points must be "product" related points for level™ 2 certification

To achieve level™ 3:

- conform with all six prerequisites
- accumulate between 63 and 90 total points; at least 18 of these total points must be "product" related points for level™ 3 certification

California Flammability Standards Bulletin CA 116 Specifies requirements, test procedure and apparatus for testing the flame retardance of upholstered furniture. Measures the cigarette ignition resistance of an actual item of upholstered furniture.

Bulletin CA 117 Specifies requirements, test procedures and apparatus for testing the flame retardance of resilient filling materials used in upholstered furniture. Measures flammability using both open flame and lighted cigarettes as the ignition sources. All upholstery components are tested.

Bulletin CA 133 Specifies the flammability test procedure for seating furniture used in public occupancies such as jails, prisons, nursing homes, healthcare facilities, public auditoriums and hotels. It tests completed items of upholstered furniture and measures the type of ignition that may be typical of arson or incendiary fires or common accidental fires in public buildings.

Composite Panel Associates EPP Downstream Program

Products carrying the EPP Downstream logo are manufactured by a company that has demonstrated its environmental commitment by purchasing at least 50% CPA EPP certified composite wood products.



NSF International NSF International, an independent, not-for-profit organization, helps protect consumers by auditing and certifying as safe: food, water and other consumer products. NSF is a World Health Organization Collaborating Centre for Food and Water Safety and Indoor Environments and an American National Standards Institute (ANSI) accredited standards developer.



ICON INDEX



Indicates a product that must be shipped freight.



Alera Access Plus



Indicates a product that requires assembly.



Small Parcel Shippable



Identifies a product which requires additional lead time.



Products certified as safe for food preparation, consumption and storage by NSF International.

Adjustable Glides: 1" to 2" leveling devices for stabilizing storage, chairs or panels. Also known as "height adjusters."

Anti-Rebound: The feature that ensures that a drawer will stay closed and not spontaneously recoil or roll out from the pedestal opening when the drawer is closed with normal force.

Articulating Keyboard:

Height-adjustable design swivels, tilts and rotates in order to facilitate the correct ergonomic position for arms, wrists and hands when typing. Retracts under the desk when not in use.

Ball Bearing Slide: A drawer device containing a number of metal or plastic balls that rotate for smooth opening and closing.

Base Cap: A solid cap that fits over a prong of the metal understructure base on a panel system.

Base Cover: The metal or extruded plastic part that covers the electrical power distribution system at the bottom of a panel system's workstation configuration.

Box Drawers: Small drawers, generally 6" in height, mainly in desks and pedestals.

Bridge Worksurface: Attaches between a desk and a credenza to form a U-shaped configuration.

Cantilever: Vertical slotted channels that accept the brackets to hang worksurfaces and storage pieces from systems furniture.

Casegoods: Refers to furniture made of hard materials, such as wood, metal, glass or plastic relating to desks, credenzas, bookcases, computer furniture and lateral files.

Caster Sleeve: A metal receptacle into which the casters are inserted.

Center Drawer (Pencil Drawer): The drawer mounted beneath a worksurface.

C-Legs: An upright furniture support leg in the shape of the letter "C."

Core (Sub-Core): Interior material used to construct veneer panels (i.e., particleboard).

Core-Removable Lock: Designed with a removable cylinder that can be interchanged as needed allowing users to access all furniture with a single key.

Credenza: A storage unit, generally 18" to 24" deep, used with desks in private offices.

Defeat Mechanism: The mechanism that helps prevent the accidental tipping of a file.

Desk—Bow Front: A desk shell in which the surface bows outward away from the user.

Desk—Double Pedestal: A worksurface with pedestals at both ends of the unit.

Desk—Table Desk: Versatile furniture component that functions as a table and/or desk depending on user's needs.

Dovetail: A flaring joint between two pieces of wood, forming an interlocking tight fit.

Drawer Dividers: A partition in a box drawer that separates or divides the front portion from the back portion.

Elevation: A line drawing providing more spatial perception of a furniture layout.

End Panels: Slab end-supports commonly found on either side of a desk worksurface.

Ergonomics: The study of equipment design to reduce operator fatigue and discomfort. A person's relationship and interaction within work environments.

Executive Chair: A high-back or padded chair designed for senior decision-makers.

Face Veneer: The most visible surface veneer.

Fiberboard: A composition board consisting of fine thread-like fibers of wood bonded together with synthetic resins.

File Drawer: A drawer that is generally 12" to 13" in height and deep enough to support hanging file folders.

Flipper Door: The front door of an overhead storage unit, common in systems or office plans.

Follower Block (in a file drawer): Interior drawer panel keeps file folders and other materials upright and toward the front of the drawer.

Footprint: The working square footage required to support a particular function; either a workstation or group of workstations.

Full-Height Pedestals: Pedestals that extend from the worksurface to the floor.

Fully Assembled: Product shipped completely built rather than in parts or as flat stock.

Gangging: The method of joining individual seating elements into one unit. Specifically refers to gangging chairs or gangging tables. Often seen in lounge areas.

Graining: The process of printing a natural woodgrain pattern onto another surface that may or may not be wood product.

Green: A term used in reference to environmentally conscious initiatives, such as recycling or using environmentally sustainable, compostable, reusable or biodegradable and/or energy efficient content in the manufacture of a product.

Grommet: A covering of a cut-out that helps drop wires and cords under a worksurface for wire management.

Guest Chair: Often referred to as a Side Chair, this is a chair used by those who visit an office for the purpose of a meeting or conference.

Hardwood: Designates lumber produced from broad-leaved or deciduous trees in contrast to softwoods from evergreen or coniferous trees.

High Pressure Laminate (HPL): Also known as plastic laminate. Produced by fusing together multiple layers of kraft paper saturated with phenolic resin, with a layer of melamine saturated decorative paper, resulting in higher impact resistance than most other laminates.

Hutch: Storage component with cabinets and/or shelves that sits above a credenza or desk.

Independent Seat and Back: On a chair, seat and back flex independently for automatic comfort.

Glossary

Inlay: Wood or other material set into corresponding carved out recesses, often producing a pattern.

Interlock Mechanism: A device that couples two or more drawers together to prevent simultaneous opening, averting injuries due to cabinet tipping.

Junction Box: An electrical outlet device or communications port box on an office wall generally requiring access for cord placement and plug-ins.

KD: Shipped Knocked Down or assembly required.

L-Unit: Consists of a front desk piece with a connecting “return” extending on either the “right” or “left” side, normally dependent on columns and entry door positioning.

Laminate: A product made by fusing thin layers of coated paper to an interior substrate.

Lateral File: A file cabinet where the file drawers are wide, as opposed to deep, allowing complete access to all files at once.

Layout: (Space Plan) A plan created by an interior designer or architect showing locations of tenant improvement and space utilization by the tenant.

Leather: Animal skin or hide that is tanned to preserve an otherwise perishable skin and protect it from water damage or bacterial decay. Various tanning methods give leather its unique character and quality. The tanning process lubricates the skin with oil to make it as pliable as possible.

Leather—Bonded: Material made of varying degrees of genuine leather combined with other substances to give the appearance of leather, but at reduced cost.

Leather—Dyed: Three processes are used to dye leather: aniline, semi-aniline and pigment (i.e., opaque color). The aniline process is used on top-of-the-line leather furniture in natural or full-grain leather. For skins with somewhat uneven color, a semi-aniline process is used that combines aniline dyeing and a pigment solution to make the colors more opaque. Pigment is used on the most heavily marked skins to completely cover them with opaque color.

Leather—Full-Grain: The thin, outer layer of a hide. Often the finest, most delicate, best quality and sophisticated in design. Aniline finishes are generally used to preserve full-grain leather.

Leather—Natural: A leather which has a distinctive smooth and supple feel, and a slightly shaded color due to the application of two-tone aniline or semi-aniline.

Leather—Pigment: A more durable leather capable of withstanding higher wear and tear. Made by a mid-priced process using more opaque pigments of semi-aniline dyeing.

Leathermate: Combination leather/vinyl that is a low-cost alternative to full leather upholstery. Typically used in low contact areas of a chair.

Legal Size: Sized for 8½ × 14 documents.

Letter Size: Sized for 8½ × 11 documents.

Leveling Glides: Support device for leveling or stabilizing furniture on uneven flooring.

Louvers: Slats that admit air and light; generally for ventilation or cooling.

Low Pressure Laminate (Melamine or TFM—Thermally Fused Melamine): Results when melamine paper is thermally bonded to particleboard or MDF panels. Offers less impact resistance than HPL.

Lumbar: The lower section of your back between the thoracic vertebrae and sacrum.

Management Chair: A mid-back chair designed for the person who spends a lot of time seated at a desk. Usually a chair with a 5-prong base fitted with casters.

Mechanism: The part of a chair that connects the seat assembly to the base and allows adjustments such as tilt, swivel, seat height, etc., to allow a user optimum comfort and productivity.

Medium Density Fiberboard (MDF): A composite wood product similar to particleboard and made out of wood waste fibers glued together with resin, heat, and pressure.

Melamine: A misused term often thought of as a type of laminate. Actually, it is a component layer found in laminate composites.

Mesh Seat: Seating products that have backs and/or seat cushion support derived from a porous, posture-fitting material.

Mitered: A joinery technique where two solid angled, beveled wood pieces are glued together at the corner

Modesty Panel (Floating, Formal, Full-Length, Full-Height, Open): A vertical sheet of material on the front of a desk covering the frame, providing privacy and reinforcement. Partial or ¾ modesty panels end approximately 8 inches above the floor. Full modesty panels extend completely to the floor.

Modular Furniture: Groups of freestanding tables, storage pieces and privacy pieces combined to give the appearance of a panel system but offering user-friendly reconfigurability.

Molding: A decorative plane or curved strip giving ornamentation or finishing.

Nesting: Describes pieces of matching furniture in descending sizes that fit inside of each other for the purpose of stacking.

Overhang: A desk’s front area that overhangs the body or panels, normally 6" to 12" that allows guests to move closer in.

Panel Systems Furniture: Modular furniture consisting of various height panels dividing space and creating privacy in general office areas. Configured with work surfaces and storage pieces.

Panels: Modular furniture sections used to define the limits of a workstation. Panels do not extend from floor to ceiling.

Particleboard: A higher quality board composed of distinct wood particles bonded together with a synthetic resin or other glues to form basic flakeboards or higher-quality fiberboards.

Partition: Inside floor-to-ceiling structures not otherwise meeting the criteria of walls. Partitions are movable or removable.

Pedestals: Storage components which consist of drawers in various configurations under a worksurface area.

Peninsula: A rounded-end top used in offices and/or workstations to accommodate meeting space. Also called a pork chop.

Plywood: Wood sheets glued together in three or more laminations.

Pocket Door: Storage doors that recess into the interior cabinet shell.

Polyethylene: The most extensively produced polymer, a lightweight thermoplastic; used especially in packaging and insulation.

Polyurethane: Various polymers used in flexible and rigid foams, elastomers and resins.

Post-Consumer Waste (PCW): Product that contains recycled material from products that have already been used by the consumer and then collected for recycling.

Posting Shelf: Pullout shelf used to sort and manage documents at the file.

Raceways: Tubes or channels designed to hold, guide and protect electrical wires.

Racking: The swaying that occurs when opening and closing the drawers of a file cabinet. Commercial file cabinets have features such as drawer suspension and leveling glides which prevent racking.

Recycled (also Recovered)

Material: Material that would have otherwise been disposed of as waste or used for energy recovery, but has instead been collected and recovered (reclaimed) as a material input thus avoiding the use of new primary materials.

Repeat: (Textile Patterns) The length and width measurement of a reappearing design or imprint on a fabric.

Retrofit: The act of improving an existing product with a newly introduced feature or attachment.

Return (V, Bridge, Corner Desk, Desk Return): A piece of furniture with a flat work surface that attaches to a desk to create an “L” configuration.

Reuse: Recovering value from a discarded resource without reprocessing or remanufacture.

Sealants: Finishing topcoat applied to an object by spray or wipe.

Seat Suspension: A system that supports the upper part of the seat assembly.

Shared Space: Two or more workers who share a single workstation and work tools.

Shell: Generally associated with modular office furniture, the desk shell is the sides (end panels), front (modesty panel) and top (work surface) of the desk.

Sled Base: On a chair, a tubular design approach to a chair’s base structure offered in either an arm/leg loop or platform rocker version.

Solid Woods: Wood panel or edge piece having minimal 5-mm thickness.

Spin Lift: On a chair, mechanical height adjustment operated by spinning a chair counter-clockwise to raise and clockwise to lower.

Spring-Activated Follower Block: A mechanism to keep files upright when file drawer is partially full.

Square Footage: Length times the width of a room, space, floorplate or fabric product.

Stained Wood: Wood with the natural color modified to some degree—to make it more even and to imitate other wood essences.

Star Base: On a chair, the base to which the casters are attached, having five “arms” and forming the shape of a star.

Suspended Pedestals: Pedestals that are hung from a worksurface and only extend three-quarter depth to the floor. Also known as “¾ pedestals.”

Suspension: The system that is used to support the drawer and facilitate its movement in and out of the pedestal, normally three-quarter or full suspensions.

Sustainability: A characteristic of a process or state that can be maintained at a certain level indefinitely. The term, in its environmental usage, refers to the potential longevity of vital human ecological support systems, such as

the planet’s climatic system, systems of agriculture, industry, forestry, fisheries and the systems on which they depend.

Swatch: A fabric sample used for determining finish and color compatibilities.

Task Chair: A chair designed to support individuals who perform task-intensive functions, set on a 5-prong centered base.

Thermally Fused Melamine (TFM): Results when melamine paper is thermally bonded to particleboard or MDF panels. Offers less impact resistance than HPL.

Tongue & Groove: A joint made by a tongue on one end of a board fitting into a corresponding groove on another edge.

U-Shape: Assembled desk, return and credenza storage that forms a U layout.

UV Finish: A color or wood finish that is light-baked onto a surface rather than rubbed on and absorbed into wood.

Vein Line: A design element, often called a “reveal,” which produces a visual demarcation of the individual pieces of the desk.

Vertical File: Filing units composed of drawers stacked vertically that store records from front to back rather than from side to side.

Waterfall Design: A softened, downward shape of a seat-front behind the back of the user’s legs that prevents nerve pressure, thereby increasing circulation.

Wire Management: The desktop grommet hole and channels used below the surface to manage cables efficiently.

Woodgrain Furniture: (Faux Wood) Exterior portions of furniture creating the impression of natural wood essence.

Workstation: A space where work is accomplished (inner office, open office area).

Worksurface: The top writing/storage surface areas of a workstation or office.



Discover stylish and affordable solutions for your entire workplace with Alera.

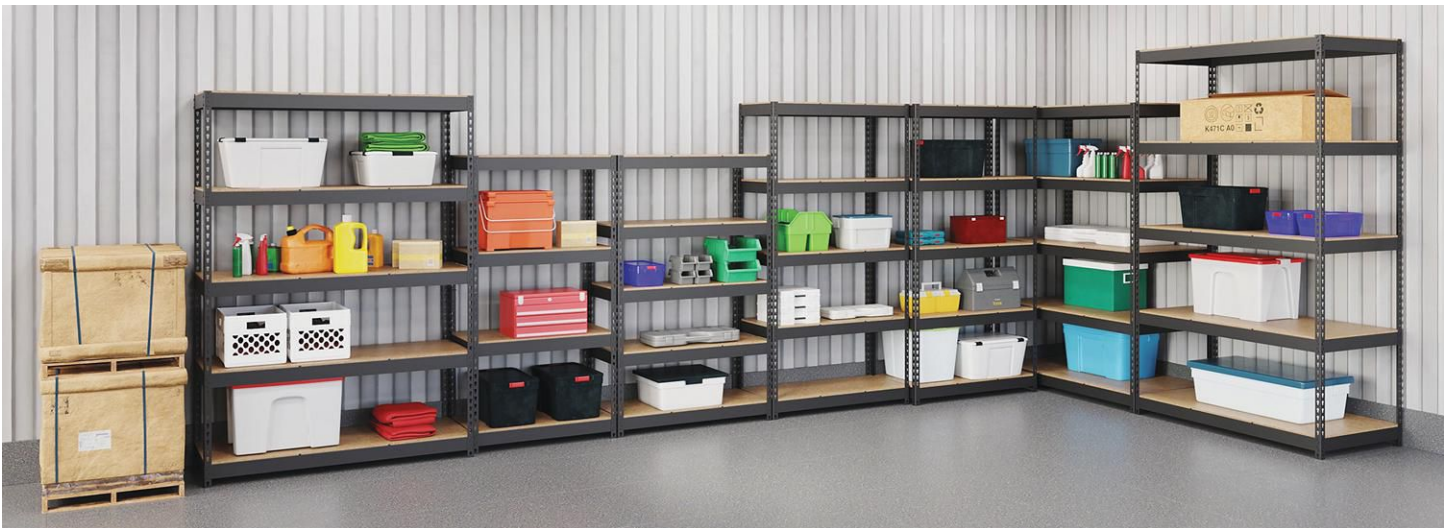

[AleraDetails.com](https://www.aleradetails.com)